

Dieffebi Collection.

Steel Design  
for Working & Living  
Made in Italy.

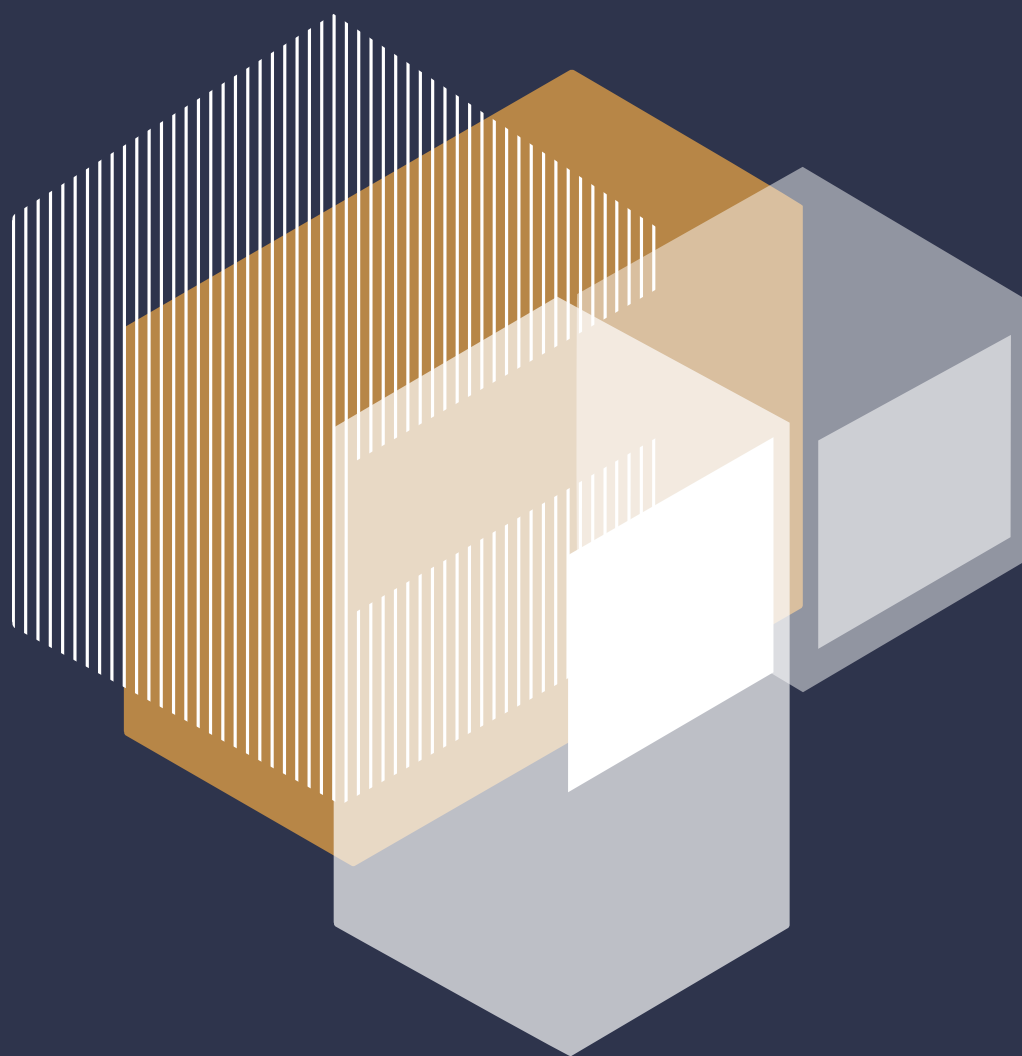

**dieffebi**

Dieffebi Collection.

Steel Design  
for Working & Living  
Made in Italy.

**dieffebi**



## Dieffebi, working and living better.

Dieffebi, una firma italiana che da oltre 40 anni interpreta la trasformazione dell'ambiente ufficio e degli spazi collettivi, nel segno della modularità, della personalizzazione e dell'ergonomia. I suoi prodotti creano un sistema versatile per ordinare e contenere, ma allo stesso tempo anche per organizzare e suddividere lo spazio, renderlo più accogliente e vivibile, consentirne l'evoluzione e la riconfigurazione nel tempo. Alla flessibilità si aggiunge l'integrazione fra l'arredo e la tecnologia, elemento fondamentale del lavoro e della vita quotidiana, per produrre una maggiore efficienza ma anche un elevato livello di benessere psicofisico. Tutto questo con una qualità totale, lungo ogni fase di un processo progettuale e produttivo che unisce la migliore cultura del Made in Italy, con i più avanzati livelli di sostenibilità ambientale.

Dieffebi is an Italian company which, for over 40 years now, has interpreted the transformation of the office environment and collective spaces as a sign of modularity, personalization and ergonomics. Its products not only create a versatile system for keeping things in order and storage, yet also for organizing and dividing space, making it more comfortable and liveable, while enabling its evolution and rearrangement over time. The integration between furniture and technology is added to flexibility, a fundamental element of work and everyday life, so as to produce greater efficiency and a high level of psychophysical well-being. All this is carried out with the utmost quality, along every stage of the design and production process which combines the best Made in Italy knowhow with the most advanced levels of environmental sustainability.

Dieffebi ist eine italienische Marke, die seit über 40 Jahren die Verwandlung von Büroräumen und Gemeinschaftsbereichen im Zeichen von Modularität, individueller Gestaltung und Ergonomie interpretiert. Die Produkte bilden ein vielseitiges System für Ordnung und Aufbewahrung, ebenso wie für die Organisation und Aufteilung des Raumes, um diesen gemütlicher und lebenswerter zu gestalten und um zeitbedingte Umgestaltungen zuzulassen. Flexibilität und eine Kombination aus Einrichtung und Technologie sind ein wesentliches Element der Arbeit und des täglichen Lebens, für eine höhere Leistungsfähigkeit, aber auch für ein besseres psychophysisches Wohlbefinden. All dies mit einer umfassenden Qualität während des gesamten Planungs- und Produktionsvorgangs, der die Kultur des Made in Italy mit höchster Umweltverträglichkeit verbindet.

Dieffebi, est une marque italienne qui depuis plus de 40 ans est spécialisée dans la transformation des bureaux et des espaces collectifs. Ces produits créent un système polyvalent pour ranger et contenir, tout en organisant et en partageant l'espace, en le rendant plus accueillant et vivable et en facilitant l'évolution et la reconfiguration. On ajoute à la flexibilité l'union entre l'aménagement et la technologie, élément fondamental du travail et de la vie quotidienne, pour obtenir un meilleur rendement mais aussi un niveau élevé de bien-être psychophysique. Tout ceci en garantissant la qualité pendant toutes les phases du processus de conception et de production qui unit la meilleure culture du Made in Italy aux niveaux de durabilité environnementale les plus avancés.

Dieffebi, una firma italiana que desde hace más de 40 años interpreta la transformación del ambiente de oficina y de los espacios colectivos, bajo el signo de la modularidad, de la personalización y de la ergonomía. Sus productos crean un sistema versátil para ordenar y contener, pero al mismo tiempo también para organizar y subdividir el espacio, volverlo más acogedor y vivible, permitirle la evolución y la reconfiguración en el tiempo. A la flexibilidad se suma la integración entre el amoblado y la tecnología, elemento fundamental del trabajo y de la vida cotidiana, para producir una mayor eficiencia pero también un elevado nivel de bienestar psicofísico. Todo esto con una calidad total, a lo largo de cada fase de un proceso proyectivo y productivo que une la mejor cultura del Made in Italy, con los más avanzados niveles de sostenibilidad ambiental.

Le 5 parole chiave dell'ufficio Dieffebi.

In ogni soluzione d'arredo Dieffebi, si ritrovano dei valori fondamentali. Eccellenza del Made In Italy: apprezzati a livello internazionale, i prodotti Dieffebi sono il frutto di un processo tecnologicamente evoluto. Smart Working: le soluzioni Dieffebi interpretano la rivoluzione dello "smart office", contribuendo a creare nuovi spazi e nuovi modi di operare. User-Oriented: Dieffebi mette le persone al centro dei propri progetti, valorizzando il loro lavoro e tutelando il loro benessere. Modularità: i prodotti Dieffebi offrono infinite possibilità di suddividere, organizzare, condividere e vivere lo spazio. Customizzazione: Dieffebi permette di realizzare ambienti altamente personalizzati nei colori e nelle composizioni.

The 5 key words of the Dieffebi office.

Fundamental values are found in every Dieffebi furnishing solution. Made In Italy excellence: admired worldwide, Dieffebi products are the result of a technologically advanced process. Smart Working: Dieffebi solutions interpret the "smart office" revolution, contributing to create new spaces and new ways to work. User-Oriented: Dieffebi puts people at the centre of their projects, enhancing their work while protecting their well-being. Modularity: Dieffebi products offer endless possibilities to divide, organize, share and live spaces. Customization: Dieffebi allows to create highly customized Environments, both in colours and compositions.

Die fünf Schlüsselwörter des Büros von Dieffebi.

In jeder Einrichtungslösung von Dieffebi sind grundlegende Werte zu finden. Herausragendes Made in Italy: Weltweit geschätzt, sind die Produkte von Dieffebi das Ergebnis eines technologisch hoch entwickelten Prozesses. Smart Working: Die Lösungen von Dieffebi interpretieren die Revolution des „Smart Office“ und tragen so dazu bei, neue Räume und neue Arbeitsweisen zu schaffen. User-Oriented: Dieffebi stellt die Menschen in den Mittelpunkt seiner Projekte und bringt so Wertschätzung gegenüber ihrer Arbeit zum Ausdruck und schützt ihr Wohlbefinden. Modularität: Die Produkte von Dieffebi bieten unzählige Möglichkeiten für die Unterteilung, Gestaltung und gemeinsame Nutzung eines Raumes. Personalisierbarkeit: Dieffebi ermöglicht das Errichten von Räumen, deren Farben und Kombinationen bis ins Detail personalisiert sind.

Les 5 mots-clés des bureaux Dieffebi.

Chaque solution d'ameublement Dieffebi est expression de valeurs fondamentales. L'excellence du Made in Italy : appréciés partout au monde, les produits Dieffebi sont le fruit de procédés technologiquement avancés. Smart-Working : les solutions Dieffebi interprètent la révolution du « bureau intelligent », en contribuant à créer de nouveaux espaces adaptés aux nouvelles façons de travailler. User-Oriented : Dieffebi met l'individu au centre de ses projets, en valorisant leur travail et en protégeant leur bien-être. Modularité : les produits Dieffebi offrent une infinité de possibilités pour subdiviser, organiser, partager et vivre l'espace. Personnalisation : Dieffebi permet de créer des espaces hautement personnalisés au niveau des couleurs et des compositions.

Las 5 palabras clave de la oficina Dieffebi.

En cada solución de amoblado Dieffebi, se encuentran los valores fundamentales. Excelencia del Made In Italy: apreciados a nivel internacional, los productos Dieffebi son el fruto de un proceso tecnológicamente evolucionado. Trabajo inteligente: las soluciones Dieffebi interpretan la revolución de la "oficina inteligente", contribuyendo a crear nuevos espacios y nuevos modos de operar. Orientado al usuario: Dieffebi pone a las personas al centro de sus proyectos, valorizando su trabajo y cuidando su bienestar. Modularidad: los productos Dieffebi ofrecen infinitas posibilidades de subdividir, organizar, compartir y vivir el espacio. Personalización: Dieffebi permite realizar ambientes altamente personalizados en los colores y en las composiciones.

# Dieffebi strategy.

Dieffebi is:

Made in Italy  
excellence.

Smart working.

User-oriented.

Modularity.

Customization.

Dieffebi è eccellenza del Made in Italy.

Fondata nel 1976 a San Vendemiano (TV), nel cuore di uno dei principali distretti industriali italiani, Dieffebi è una realtà con profonde radici nel proprio territorio, ma allo stesso tempo proiettata verso gli scenari e le tendenze internazionali. Organizzata secondo i principi della "lean production", filosofia che elimina gli sprechi concentrandosi sulla produzione di valori e sul miglioramento continuo, con un sistema di qualità totale ISO 9001 e di gestione ambientale ISO 14001, Dieffebi esporta l'eccellenza italiana in oltre 50 paesi del mondo, confrontandosi con mercati diversi ed esigenze in costante trasformazione.

Dieffebi is Made in Italy excellence.

Founded in 1976 in San Vendemiano (TV), in the heart of one of Italy's leading industrial districts, Dieffebi is a reality with solid roots in its territory. However, it is also projected towards international scenarios and trends. Dieffebi is organized according to the principles of "lean production", a philosophy that eliminates waste by focusing on value production and continuous improvement. It has an ISO 9001 total quality system and an ISO 14001 environmental management system certification and exports Italian excellence to over 50 countries around the world, confronting itself with different markets and constantly changing needs.

Dieffebi ist Qualität Made in Italy.

1976 in San Vendemiano (TV) im Herzen eines der wichtigsten italienischen Industriegebiete gegründet, orientiert sich Dieffebi trotz seiner tiefen Verwurzelung in der Region an den internationalen Gegebenheiten und Tendenzen. Nach den Prinzipien der „lean production“, eine gegen die Verschwendung gerichtete Philosophie, die sich mit einem umfassenden Qualitätsmanagement ISO 9001 und Umweltmanagement 14001 auf eine hochwertige Produktion und kontinuierliche Verbesserung konzentriert, exportiert Dieffebi italienische Qualität weltweit in über 50 Länder und setzt sich mit unterschiedlichen Märkten und sich ständig ändernden Anforderungen auseinander.

Dieffebi : l'excellence Made in Italy.

Fondée en 1976 à San Vendemiano (TRÉVISE), au cœur d'un des principaux quartiers industriels italiens, Dieffebi est une réalité enracinée à son propre territoire tout en étant projetée vers les scénarios et les tendances internationales. Organisée selon les principes de la « lean production », philosophie qui élimine les gaspillages en se concentrant sur la production des valeurs et sur l'amélioration constante, avec un système de qualité ISO 9001 et de gestion environnementale ISO 14001, Dieffebi exporte l'excellence italienne dans plus de 50 pays dans le monde, en se mesurant avec les différents marchés et les exigences en constante mutation.

Dieffebi es trabajo inteligente.

Fundada en el 1976 en San Vendemiano (TV), en el corazón de uno de los principales distritos industriales italianos, Dieffebi es una realidad con profundas raíces en el propio territorio, pero al mismo tiempo proyectada hacia los escenarios y las tendencias internacionales. Organizada según los principios de la "producción ajustada", filosofía que elimina los desperdicios concentrándose en la producción de valores y en el mejoramiento continuo, con un sistema de calidad total ISO 9001 y de gestión ambiental ISO 14001, Dieffebi exporta la excelencia italiana a más de 50 países del mundo, enfrentándose con diversos mercados y exigencias en constante transformación.

# Dieffebi is Made in Italy excellence.



Dieffebi è Smart Working.

Il concetto di "Smart Working" è alla base di una profonda trasformazione dell'ambiente ufficio, attraverso un processo complesso e non racchiudibile in risposte generiche e soluzioni standardizzate. I nuovi uffici nascono dalla diffusione di strumenti di comunicazione e connessione che consentono di lavorare online in qualsiasi spazio e momento ma anche da un'evoluzione culturale e sociale che individua, come valori fondanti, la libertà, la realizzazione di sé stessi, l'armonia fra corpo, mente e ambiente. Dieffebi risponde a questa rivoluzione in corso, con soluzioni che permettono agli utenti di scegliere fra diverse situazioni, a seconda dell'attività che desiderano svolgere: da soli o in gruppo, con un design e un'ergonomia che mettono la persona al centro di ogni situazione.

Dieffebi is Smart Working.

The concept of "Smart Working" is the basis for a profound transformation in the office environment, which is taking place through a complex process that cannot be enclosed in generic responses and standardized solutions. New offices are being created from the diffusion of communication and connection tools that enable to work online in any space and time, but also from a cultural and social evolution that identifies, as founding values, freedom, self-realization and harmony between body, mind and environment. Dieffebi is responding to this ongoing revolution with solutions that allow users to choose between various situations, depending on the activity they want to carry out: either alone or in a group, with a design and ergonomics that place the person at the centre of each situation.

Dieffebi ist Smart Working

Das „Smart Working“-Konzept basiert auf einer grundlegenden Umgestaltung der Büroumgebung in einem komplexen Prozess, der sich nicht durch allgemeine und standardisierte Lösungen umsetzen lässt. Die neuen Büros entstehen aus der Verbreitung von Kommunikationsmitteln und Verbindungssystemen, die es ermöglichen, an jedem Ort und zu jeder Zeit online zu arbeiten, aber auch aus einer kulturellen und sozialen Evolution, zu deren grundlegenden Werten Freiheit, Selbstverwirklichung und Harmonie zwischen Körper, Geist und Umwelt zählen. Dieffebi antwortet auf diese laufende Revolution mit Lösungen, die es den Nutzern ermöglicht, je nach Art der gewünschten auszuführenden Tätigkeit, zwischen verschiedenen Möglichkeiten zu wählen: allein oder im Team, mit einem Design und einer Ergonomie, die den Menschen in den Mittelpunkt stellt.

Dieffebi est synonyme de travail intelligent.

Le principe du « travail intelligent » est à la base d'une profonde transformation des bureaux à travers un processus complexe qui ne peut être affronté avec des réponses génériques et des solutions standardisées. Les nouveaux bureaux naissent de la diffusion d'instruments de communication et de connexion permettant de travailler en ligne n'importe où et à n'importe quel moment mais aussi d'une évolution culturelle et sociale qui définit, comme des valeurs essentielles, la liberté la réalisation de soi, l'harmonie entre le corps, l'esprit et l'environnement. Dieffebi répond à cette révolution, avec des solutions permettant aux utilisateurs de choisir parmi différentes situations, en fonction de l'activité qu'ils souhaitent exercer : seuls ou en groupe, avec une ergonomie et un design qui placent l'individu au centre de chaque situation.

Dieffebi es trabajo inteligente.

El concepto de "trabajando inteligente" se encuentra en la base de una profunda transformación del ambiente de oficina, a través de un proceso complejo y que no se puede encerrar en respuestas genéricas y soluciones estandarizadas. Las nuevas oficinas nacen de la difusión de instrumentos de comunicación y conexión que permiten trabajar en línea en cualquier espacio y momento pero también de una evolución cultural y social que individua, como valores fundamentales, la libertad, la realización de sí mismos, la armonía entre cuerpo, mente y ambiente. Dieffebi responde a esta revolución en curso con soluciones que permiten a los usuarios escoger entre diversas situaciones, según la actividad que desean desarrollar: solos o en grupo, con un diseño y una ergonomía que colocan a la persona en el centro de cada situación.

# Dieffebi is Smart Working.



Dieffebi è User-Oriented.

L'ambiente di lavoro è un'estensione delle persone che trascorrono al suo interno gran parte della giornata, delle loro esigenze di funzionalità ed efficienza, ma anche del loro desiderio di vivere un ambiente accogliente, piacevole e stimolante. Dieffebi mette la tecnologia e il design al servizio degli utenti, creando soluzioni che permettono di esprimere le potenzialità dello spazio e quelle delle persone. Ambienti nei quali sentirsi a proprio agio e liberi di svolgere il proprio lavoro nei modi, tempi e spazi che desideriamo, con un comfort e un benessere che coinvolgono tutti i sensi: dalla riduzione del rumore e del riverbero, alla qualità dell'atmosfera indoor.

Dieffebi is user-oriented.

The work environment is an extension of the people who spend most of their day inside it, their need for functionality and efficiency, but also their desire to live in a comfortable, pleasant and stimulating environment. Dieffebi puts technology and design at the service of users, creating solutions that make it possible to express the potential of space and people; environments in which to feel comfortable and free and carry out work in the ways, times and spaces we want, with comfort and well-being that include all the senses: from noise and reverb reduction to the quality of the indoor atmosphere.

Dieffebi ist nutzerorientiert.

Der Arbeitsplatz ist ein Teil der Menschen, die an diesem Ort einen Großteil des Tages verbringen, ihrer Funktions- und Leistungsansprüche, aber auch ihres Verlangens, eine gemütliche, angenehme und anregende Umgebung zu leben. Dieffebi stellt Technologie und Design in den Dienst der Nutzer und entwickelt Lösungen, um das Potenzial von Raum und Mensch zum Ausdruck zu bringen. Umgebungen, in denen man sich wohl fühlt und wo man die Freiheit genießt, die eigene Arbeit auf die gewünschte Art, in der gewünschten Zeit und im gewünschten Raum zu verrichten, mit Komfort und Wohlbefinden unter Einbeziehung aller Sinne: von der Lärmdämmung und Hallreduzierung bis zur Qualität der Raumluft.

Dieffebi est centré sur l'utilisateur.

L'environnement de travail est un groupe de personnes qui y vivent une grande partie de leur journée, de leurs exigences de fonctionnalité et d'efficacité, mais aussi de leur désir de vivre au sein d'un milieu accueillant, agréable et stimulant. Dieffebi met la technologie et le design au service des utilisateurs, en créant des solutions qui permettent d'exprimer les capacités de l'espace et celles des personnes. Des milieux à l'intérieur desquels vivre aisément et être libre d'exercer son propre travail selon les méthodes, les temps et les espaces souhaités, avec un confort et un bien-être impliquant tous les sens : de la réduction du bruit et de la réverbération, à la qualité de l'atmosphère intérieure.

Dieffebi está enfocado al usuario.

El ambiente de trabajo es una extensión de las personas que transcurren en su interior gran parte del día, de sus exigencias de funcionalidad y eficiencia, pero también de su deseo de vivir un ambiente acogedor, placentero y estimulante. Dieffebi coloca la tecnología y el diseño al servicio de los usuarios, creando soluciones que permiten expresar las potencialidades del espacio y las de las personas. Ambientes en los cuales sentirse cómodos y libres de desarrollar el propio trabajo en los modos, tiempos y espacios que deseamos, con un confort y un bienestar que involucran todos los sentidos: desde la reducción del ruido y del reverbero, a la calidad de la atmósfera interior.





Dieffebi è modularità.

Tutti i prodotti Dieffebi esprimono un concetto di modularità che permette infinite soluzioni, in sintonia con lo spazio a disposizione, le sue caratteristiche architettoniche, la sua identità ma anche con le esigenze delle persone. Scrivanie, contenitori e librerie sono concepiti non come semplici complementi d'arredo, nel senso tradizionale d'arredo, ma come strumenti per progettare scenari di vita e di lavoro, adattandosi ad una molteplicità di utilizzi e di situazioni in continuo cambiamento. La modularità dei prodotti Dieffebi consente di creare soluzioni complete, coerenti ed efficienti con la massima semplicità, anche in spazi difficili o con caratteristiche ibride fra l'ambiente ufficio e lo spazio domestico.

Dieffebi is modularity.

All Dieffebi products express a modular concept that allows for infinite solutions, in line with the space available, its architectural features, its identity and also the needs of people. Desks, containers and bookcases are not simply conceived as complementary furnishings in a traditional manner, but as tools for designing life and work scenarios, while adapting to a wide variety of uses and situations that are constantly changing. The modularity of Dieffebi's products allows for the creation of complete, consistent and efficient solutions with the utmost simplicity, even in difficult or hybrid spaces within the office environment and domestic spaces.

Dieffebi ist Modularität.

Alle Produkte zeichnen sich durch ein Konzept der Modularität aus, das unendliche Lösungen ermöglicht, die im Einklang mit dem verfügbaren Raum, dessen architektonischen Eigenschaften, seiner Identität, aber auch mit den Ansprüchen des Menschen stehen. Schreibtische, Schränke und Regale wurden nicht wie traditionsgemäß als reine Möbelergänzungen konzipiert, sondern als Instrumente zur Planung von Lebens- und Arbeitsschauplätzen, die sich an eine Vielzahl von Anwendungen und ständig verändernden Situationen anpassen. Die Modularität der Produkte von Dieffebi ermöglicht eine einfache Realisierung von kompletten, konsequenten und effizienten Lösungen, auch in problematischen Räumen oder bei Kombinationen aus Büro & Heim.

Dieffebi est synonyme de modularité.

Tous les produits Dieffebi expriment un principe de modularité permettant d'innombrables solutions, en syntonie avec l'espace disponible, ses caractéristiques architectoniques, son identité mais aussi les exigences des personnes. Les bureaux, les meubles de rangement et les bibliothèques ne sont pas conçus simplement comme compléments d'ameublement, au sens traditionnel du terme, mais comme des instruments pour concevoir des scénarios de vie et de travail et s'adapter aux nombreuses utilisations et situations en constante évolution. La modularité des produits Dieffebi permet de créer avec extrême simplicité des solutions complètes, cohérentes et efficaces mais aussi des espaces difficiles ou avec des caractéristiques hybrides entre l'environnement de bureau et l'espace domestique.

Dieffebi es modularidad.

Todos los productos Dieffebi expresan un concepto de modularidad que permite infinitas soluciones, en sintonía con el espacio a disposición, sus características arquitectónicas, su identidad pero también con las exigencias de las personas. Escritorios, contenedores y librerías están concebidos no como simples complementos de amoblado, en el sentido tradicional de amoblado, sino como instrumentos para proyectar escenarios de vida y de trabajo, adaptándose a una multiplicidad de usos y de situaciones en continuo cambio. La modularidad de los productos Dieffebi permite crear soluciones completas, coherentes y eficientes con la máxima simplicidad, incluso en espacios difíciles o con características híbridas entre el ambiente oficina y el espacio doméstico.

# Dieffebi is modularity.



Dieffebi è customizzazione.

Grazie alla modularità dei suoi sistemi d'arredo ed alla flessibilità della sua organizzazione, Dieffebi può realizzare delle soluzioni personalizzate per ogni spazio e funzione, mettendo al servizio dei progettisti la propria esperienza e la propria ricerca, per definire insieme il layout degli spazi di lavoro, in sintonia con ogni esigenza operativa, estetica e di budget. La personalizzazione dei prodotti comprende un'ampia proposta cromatica e l'integrazione dell'arredo con sistemi tecnologici, per creare ambienti stimolanti e multifunzionali.

Dieffebi is customization.

Thanks to the modularity of its furnishing systems and the flexibility of its organization, Dieffebi can create customized solutions for each space and function, by providing designers with its expertise and research to jointly define the work space layout, in tune with every operational, aesthetic and budget need. Customization of the products includes a wide range of colour choices and the integration of furnishings with technological systems so as to create stimulating and multifunctional environments.

Dieffebi ist Maßanfertigung.

Dank der Modularität der Einrichtungssysteme und der flexiblen Gestaltbarkeit, kann Dieffebi individuell gestaltete Lösungen für jede Umgebung und Funktion umsetzen, indem das Unternehmen den Planern seine Erfahrung anbietet, um die Raumaufteilung am Arbeitsplatz im Einklang mit Arbeitsansprüchen, Ästhetik und Budget gemeinsam zu bestimmen. Die individuelle Gestaltbarkeit der Produkte umfasst eine breite Farbauswahl und die Einrichtungsergänzungen mit technischen Systemen für stimulierende und multifunktionale Umgebungen.

Dieffebi est synonyme de personnalisation.

Grâce à la modularité de ses systèmes d'ameublement et à la flexibilité de son organisation, Dieffebi est en mesure de réaliser des solutions personnalisées pour chaque espace et fonction, en mettant au service des ingénieurs sa propre expérience et la recherche afin de définir ensemble le schéma des espaces de travail en syntonie avec les exigences opérationnelles, esthétiques et financières. La personnalisation des produits dispose d'une vaste proposition de couleurs et l'intégration de l'aménagement avec des systèmes technologiques pour créer des pièces stimulantes et multi-fonctionnelles.

Dieffebi es personalización.

Gracias a la modularidad de sus sistemas de amoblado y a la flexibilidad de su organización, Dieffebi puede realizar soluciones personalizadas para cada espacio y función, colocando al servicio de los proyectistas la propia experiencia y la propia búsqueda, para definir juntos el esquema de los espacios de trabajo, en sintonía con toda exigencia operativa, estética y de presupuestos. La personalización de los productos comprende una amplia propuesta cromática y la integración del amoblado con sistemas tecnológicos, para crear ambientes estimulantes y multifuncionales.

# Dieffebi is customization.





# Collection

## Products

### DotBox

- 020 DotBox Evolution
- 032 DotBox

### Primo

- 044 Primo 1000
- 047 Primo 800
- 053 Primo 800 Laterals
- 058 Primo Sliding Doors with Flush Front
- 067 Primo Sliding Doors
- 068 Primo Sliding Doors Acoustic
- 076 Primo Acoustic
- 084 Primo Tambours

### Classic Storage

- 092 Sliding Door Cabinets
- 098 Hinged Door Cabinets
- 100 Tempered Glass Sliding Door Cabinets

### Bookcases

- 104 Chiave di Volta
- 110 CWave

### Lockers

- 118 Primo Lockers
- 128 Trendline Silver

### Personal Storage

- 132 CBox
- 138 Universal Quick
- 144 Mia Ped
- 150 Professional
- 152 Vertical File

- 160 Technical pages



DotBox – Units  
Flowers container  
Module 800 x 410 x 180 H mm

## DotBox Evolution

DotBox Evolution è una famiglia di tavoli di diverse dimensioni, utilizzabili in maniera indipendente oppure in combinazione con i contenitori DotBox della collezione Dieffebi, per realizzare delle postazioni di lavoro completamente personalizzate. I piani possono essere in melaminico oppure in metallo, con struttura di base predisposta per il passaggio dei cavi. La famiglia dei tavoli DotBox Evolution è completata da pannelli con rivestimento in tessuto di diversi colori, per suddividere le postazioni di lavoro creando un ambiente cromaticamente stimolante. I contenitori più bassi possono essere dotati di cuscini con funzione di comoda seduta.



DotBox Evolution – Units  
Module 800 x 410 x 400 H mm  
800 x 410 x 627 H mm  
Table 1600 x 1600 x 740 H mm

DotBox – Units  
Flowers container  
Module 800 x 410 x 180 H mm

DotBox Evolution is a series of various sized tables, which can be used independently or in combination with the Dieffebi DotBox containers collection, in order to create fully customized workstations. The surfaces can be made in either melamine or metal, with a base frame prearranged for easy passage of cables. The DotBox Evolution series tables is complemented by fabric-coated panels that come in various colours that can divide the workstations, thus creating a stimulating chromatic environment. The lower containers can be equipped with comfortable seat cushions.

DotBox Evolution ist eine Produktfamilie von Tischen unterschiedlicher Größe, die unabhängig oder in Kombination mit den DotBox Schränken der Dieffebi-Kollektion verwendet werden können, um einen komplett individuellen Arbeitsplatz zu realisieren. Die Tischplatten können aus Melamin oder Metall bestehen, mit einer Grundstruktur mit Kabeldurchlauf. Die Familie der Tische DotBox Evolution wird durch Platten mit Stoffüberzügen in verschiedenen Farben vervollständigt, um die Arbeitsplätze zu unterteilen und eine farblich stimulierende Atmosphäre zu erzeugen. Die niedrigeren Kästen können mit Polstern als bequeme Sitzgelegenheit versehen werden.

DotBox Evolution est une ligne de tables de différentes dimensions, utilisable de manière indépendante ou combinée avec les meubles de rangement DotBox de la collection Dieffebi, pour réaliser des postes de travail entièrement personnalisés. Les plans sont disponibles en mélaminé ou en métal, avec une structure de base prévue pour le passage des câbles. La ligne de tables DotBox Evolution est enrichie de panneaux revêtus en tissu de différentes couleurs, pour partager les postes de travail en créant une pièce aux couleurs stimulantes. Les meubles de rangement les plus bas peuvent être équipés de coussins et se transformer en assises.

DotBox Evolution es una familia de mesas de diversas dimensiones, utilizables de manera independiente o en combinación con los contenedores DotBox de la colección Dieffebi, para realizar posiciones de trabajo completamente personalizadas. Los tableros pueden ser en melamina o en metal, con estructura de base predispuesta para el paso de los cables. La familia de las mesas DotBox Evolution es completada por paneles con revestimiento en tejido de diversos colores, para subdividir las posiciones de trabajo creando un ambiente cromáticamente estimulante. Los contenedores más bajos pueden ser dotados de cojines con función de cómodo asiento.



DotBox - Units  
Flowers container  
Module 800 x 410 x 180 H mm

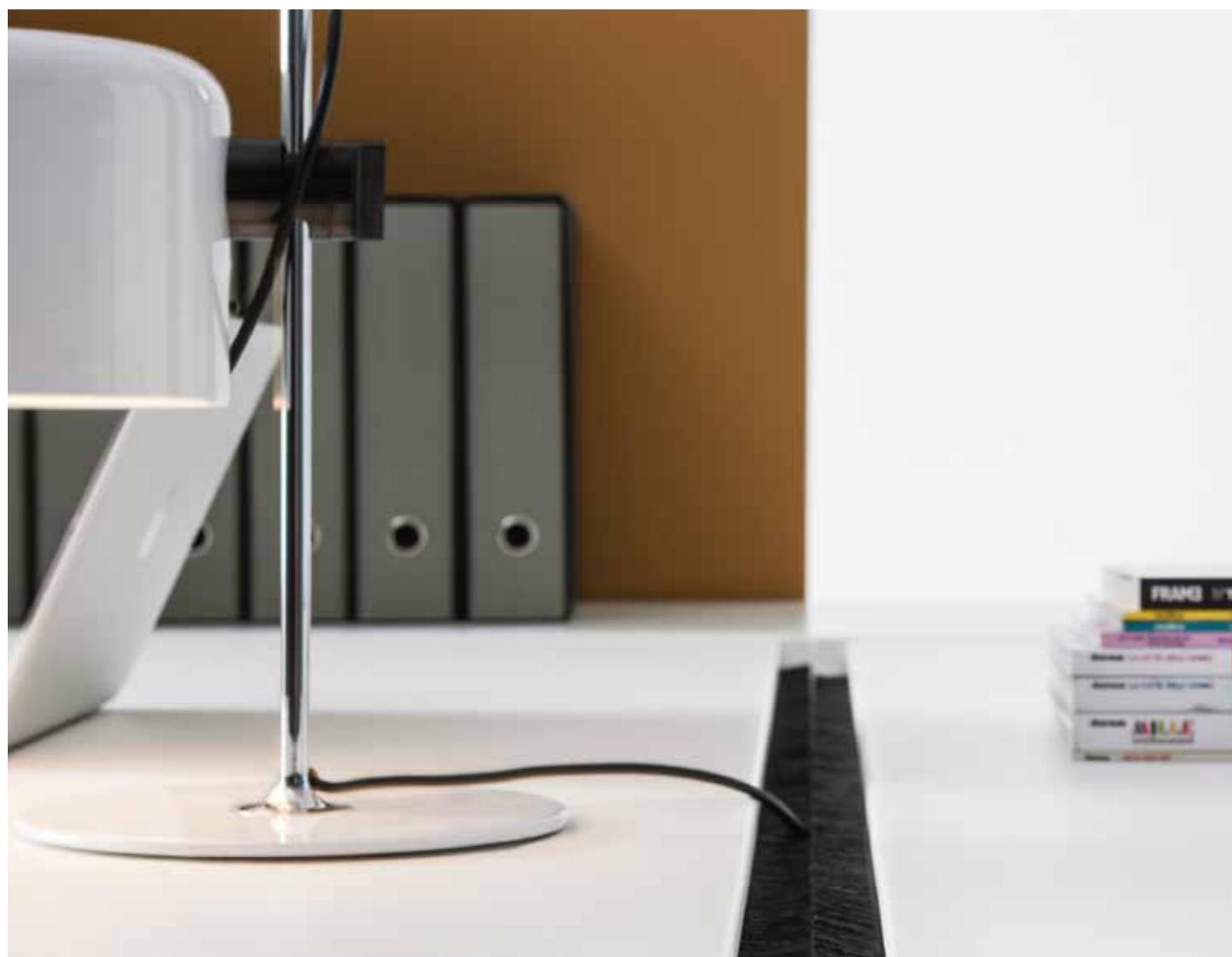

DotBox Evolution  
Table 1600 x 1600 x 740 H mm



Acoustic panel for table module  
1370/1570 x 30 x 390 H mm







DotBox Evolution  
Tables 1600 x 800 x 740 H mm  
Mia Ped – Personal Storage  
427 x 529 x 460 H mm



DotBox Evolution  
Tables 1600 x 800 x 740 H mm  
Mia Ped – Personal Storage  
427 x 529 x 460 H mm

## DotBox

Nato dalla grande esperienza Dieffebi nel campo del contenimento, il sistema modulare DotBox si presta a infinite composizioni in orizzontale o verticale. Questa flessibilità gli consente di essere utilizzato in altrettanto innumerevoli situazioni: dagli ambienti open space, dove si presta a suddividere aree e organizzare aree diverse, agli spazi di dimensioni più contenute, per una molteplicità di utilizzi. L'alta qualità della realizzazione e il livello delle finiture, sia frontalmente che lateralmente e sul retro, rendono questi contenitori degli autentici protagonisti dello spazio, mentre la loro robusta realizzazione in metallo garantisce una lunga durata nel tempo.

DotBox – Units  
 Module 800 x 410 x 400 H mm  
 400 x 410 x 400 H mm



DotBox – Units  
Module 800 x 410 x 400 H mm  
400 x 410 x 400 H mm



DotBox – Units  
Module 800 x 410 x 400 H mm  
with cushion



DotBox – Units  
Module 800 x 410 x 400 H mm



DotBox – Units  
Module 800 x 410 x 400 H mm

Created by Dieffebi's invaluable experience in the containers sector, the DotBox modular system lends itself to infinite horizontal or vertical compositions. This flexibility allows it to be used in countless situations: from open space environments, where it lends itself to subdividing areas and organizing different areas, to smaller spaces, for a variety of uses. The high quality production and the finishing levels, both front, side and rear, make these containers the true protagonists of space, while their robust metal construction guarantees a long lasting durability.

Das aus der langen Erfahrung von Dieffebi auf dem Gebiet der Aufbewahrungssysteme entstandene modulare System DotBox eignet sich für unendliche Zusammenstellungen in horizontaler oder vertikaler Lage. Dank dieser Flexibilität kann es in ebenso unzähligen Situationen für vielfältige Anwendungen eingesetzt werden: von den Open-Space-Umgebungen, wo es sich für die Zonenunterteilung und Organisation verschiedener Bereiche eignet, bis zu kleiner dimensionierten Räumen. Die hochwertige Qualität und Feinverarbeitung auf der Vorderseite, seitlich und auf der Rückseite machen diese Kästen zu authentischen Protagonisten des Raumes, deren robuste Metallausführung eine lange Lebensdauer verspricht.

Né de la grande expérience Dieffebi dans le domaine du rangement, le système modulaire DotBox propose de nombreuses positions horizontales ou verticales. Cette flexibilité lui permet de s'adapter à de nombreuses situations : des open spaces (pour partager et organiser les espaces) aux pièces plus petites où il s'adapte à de nombreuses utilisations. La qualité optimale de la réalisation et le niveau des finitions (frontales, latérales et postérieures) font de ces meubles de rangement les protagonistes de l'espace alors que la réalisation robuste en métal en garantit la durabilité.

Nacido de la gran experiencia Dieffebi en el campo de la contención, el sistema modular DotBox se presta para infinitas composiciones en horizontal o vertical. Esta flexibilidad le permite ser utilizado igualmente en innumerables situaciones: desde los ambientes abiertos, donde se presta para subdividir áreas y organizar áreas diversas, a los espacios de dimensiones más contenidas, para una multiplicidad de usos. La alta calidad de la realización y el nivel de los acabados, tanto frontalmente como lateralmente y en la parte posterior, hacen estos contenedores auténticos protagonistas del espacio, mientras su robusta realización en metal garantiza una larga duración en el tiempo.



DotBox – Units  
Module 800 x 410 x 400 H mm

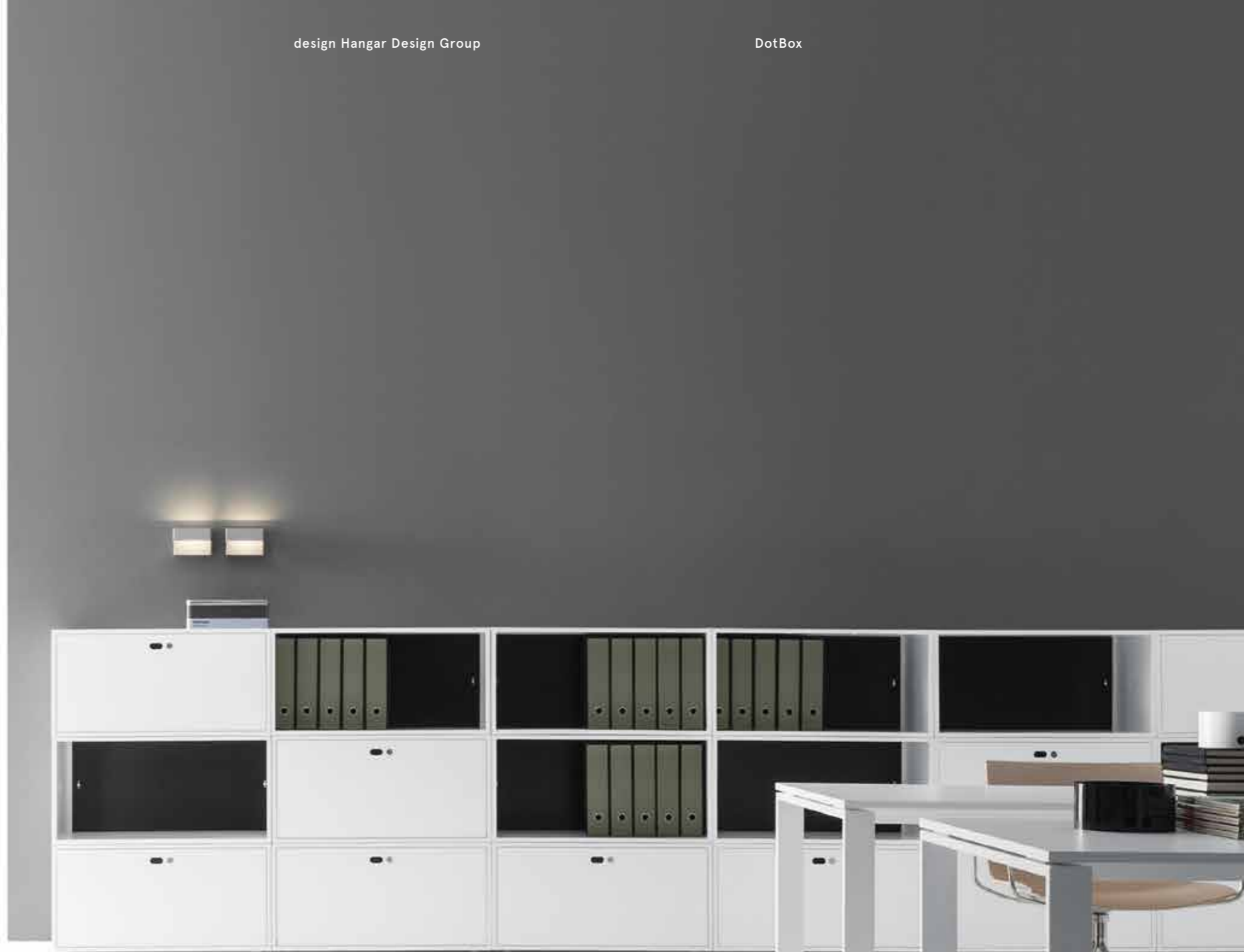

DotBox – Units  
Module 800 x 410 x 400 H mm



DotBox Evolution – Table  
1800 x 800 x 740 H mm



DotBox – Units  
Module 800 x 410 x 400 H mm



DotBox – Units  
Module 800 x 410 x 400 H mm

## Primo

Gli armadi Primo con ante battenti abbinano una piacevole essenzialità nel design, a un'elevata capacità di contenimento. Realizzati in metallo, disponibili in diverse altezze (da 1 a 5 dox), inseribili in qualsiasi spazio e facilmente aggregabili in composizioni multiple, possono essere utilizzati anche per suddividere e organizzare l'ambiente. I ripiani regolabili interni sono già predisposti con portacartelle.







Primo 1000 – Cabinet  
1000 x 450 x 2000 H mm



Primo 800 – Cabinet  
800 x 450 x 1170 H mm





Primo 1000 – Cabinet  
Lock and key details



Primo 1000 – Cabinet



Primo cabinets, with swing doors, combine a pleasing essence in design, with a high storage capacity. Made of metal, available in various heights (from 1 to 5 dox), they can be placed in any space and easily aggregated in multiple compositions and they can also be used to split and organize the environment. The internal, adjustable shelves come with filing drawers.

Die Schränke "Primo" mit Flügeltüren verbinden angenehmes essentielles Design mit großem Fassungsvermögen. In Metallausführung, erhältlich in verschiedenen Höhen (von 1 bis 5 dox), an jedem Ort einsetzbar und leicht in mehrfachen Zusammenstellungen montierbar, können sie auch für die Unterteilung und Organisation des Raumes verwendet werden. Die verstellbaren Fächer sind bereits mit Ordnerhaltern versehen.

Les armoires Primo à portes battantes combinent un design essentiel à une capacité élevée de rangement. Réalisées en métal, disponibles en plusieurs hauteurs (de 1 à 5 box), elles trouvent leur place dans n'importe quelle pièce, s'adaptent facilement aux compositions multiples et peuvent être utilisées aussi pour partager et organiser la pièce. À l'intérieur, les tablettes réglables sont déjà équipées de porte-documents.

Los armarios Primo con puertas batientes combinan una agradable esencialidad en el diseño, a una capacidad de contención. Realizados en metal, disponibles en diversas alturas (de 1 a 5 dox) insertables en cualquier espacio y fácilmente añadibles en composiciones múltiples, pueden ser utilizados también para subdividir y organizar el ambiente. Los estantes regulables internos están ya dispuestos con portacarpetas.

Primo 1000 – Units  
1000 x 450 x 1370 H mm



Primo 800 Laterals – Units  
800 x 450 x 1010 H mm



Table  
1800 x 800 x 740 H mm



Primo Sliding Doors – Units  
2000 x 450 x 1170 H mm





Table  
1800 x 800 x 740 H mm  
Primo 800 Laterals – Units  
800 x 450 x 1010 H mm



Primo 800 Laterals – Units  
800 x 450 x 1010 H mm



Primo 1000 Modular Elements



Primo 1000 Modular Elements  
1000 x 450 x 1370 H mm

## Primo Sliding Doors with Flush Fronts

Questa versione degli armadi Primo è dotata di porte scorrevoli ed è realizzata con particolari accorgimenti tecnici, per assicurare la massima facilità di assemblaggio e scorrevolezza nell'apertura e nella chiusura. Il meccanismo di regolazione presente sia sull'armadio che sulle ante, consente un'installazione perfettamente calibrata anche su pavimenti sconnessi o con dislivelli. Disponibili anche con sistema di chiusura soft closing per un funzionamento ancora più dolce e silenzioso.

Primo Sliding Doors  
with Flush Fronts  
1600 x 450 x 1170 H mm





Primo Sliding Doors  
with Flush Fronts  
1600 x 450 x 1170 H mm







Primo Sliding Doors  
with Flush Fronts  
1600 x 450 x 1170 H mm  
Sliding System Detail



Primo Sliding Doors  
with Flush Fronts  
1600 x 450 x 1170 H mm



Primo Sliding Doors  
with Flush Fronts  
1600 x 450 x 1170 H mm



Primo Sliding Doors  
with Flush Fronts  
1600 x 450 x 1170 H mm

This version of the Primo Cabinets is equipped with sliding doors and is made with special technical details to ensure the maximum ease of assembly and smoothness when opening and closing. The regulation mechanism on both the cabinet and the doors allows a perfectly calibrated installation even on disjointed floors. They're also available with a 'soft-closure' system for even quieter functioning.

Diese Version der Schränke Primo ist mit Schiebetüren und mit besonderen technischen Details umgesetzt, um eine sehr einfache Montage und ein leichtgängiges Öffnen und Schließen zu gewährleisten. Der sowohl im Schrank als auch in den Türen vorhandene Regulierungsmechanismus erlaubt eine perfekt maßgenaue Installation, auch auf unebenen Böden. Erhältlich auch mit Verschlussystem Soft Closing für eine noch angenehmere und geräuschlosere Funktion.

Cette version d'armoires Primo est équipée de portes coulissantes et réalisée avec des détails techniques spécifiques pour faciliter au maximum l'assemblage et la fluidité de l'ouverture et de la fermeture. Le mécanisme de réglage présent aussi bien sur l'armoire que sur les portes permet une installation parfaitement calibrée même sur les planchers disjoints ou dénivelés. Elles sont disponibles aussi avec système de fermeture soft closing pour un fonctionnement encore plus soft et silencieux.

Esta versión de los armarios Primo está dotada de puertas corredizas y está realizada con particulares procedimientos técnicos, para asegurar la máxima facilidad de ensamblaje y fácil deslizamiento a la apertura y al cierre. El mecanismo de regulación presente tanto en el armario como en las puertas, permite una instalación perfectamente calibrada incluso en pavimentos escabrosos o con desniveles. Disponibles también con sistema de cierre soft closing para un funcionamiento aún más dulce y silencioso.



Primo Sliding Doors – Units  
2000 x 450 x 1170 H mm



## Primo Sliding Doors Acoustic

In questa variante degli armadi Primo Sliding Doors, le ante sono realizzate con pannelli in lamiera microforata con materiale fonoassorbente sul retro. Una soluzione che abbina la funzione di contenimento a quella di riduzione del riverbero e della rumorosità all'interno dell'ambiente di lavoro.



Primo Sliding Doors Acoustic  
Module 2000 x 450 x 1170 H mm

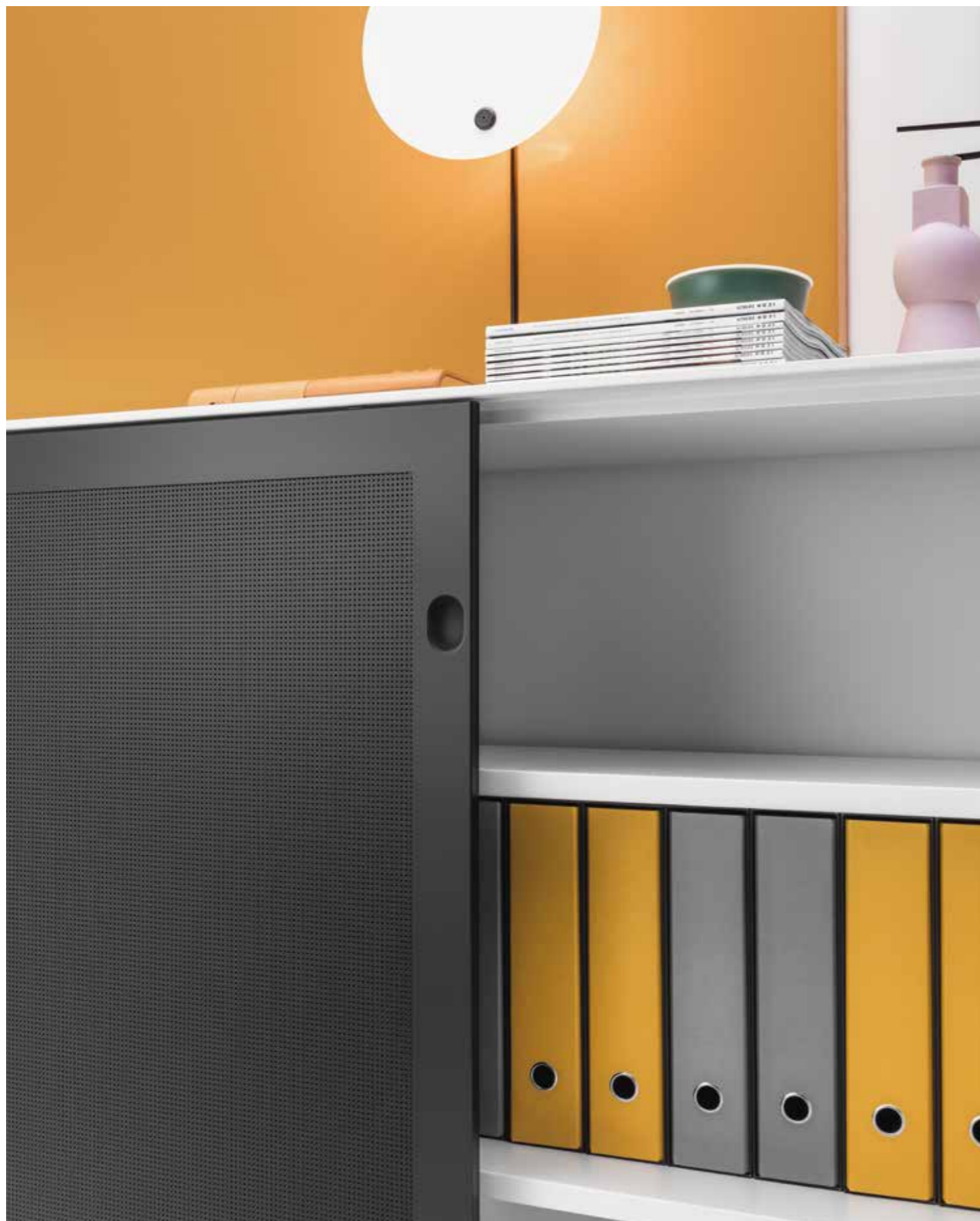

In this variant of the Primo Sliding Doors cabinets, the doors are made of micro-perforated sheet metal panels with sound-absorbing material on the back. A solution that combines the storage function with reverb and noise reduction within the working environment.

Bei dieser Variante der Schränke Primo Sliding Doors sind die Türen in mikroperforiertem Blech mit geräuschkämmendem Material auf der Rückseite realisiert. Eine Lösung, die die Aufbewahrungsfunktion mit der Lärmdämmungsfunktion innerhalb des Arbeitsbereiches verbindet.

Les portes de la version Primo Sliding Doors sont réalisées avec des panneaux en tôle microperforée et matériau insonorisant sur la partie arrière. Une solution qui associe la fonction rangement à celle de réduction de la réverbération dans le milieu de travail.

En esta variante de los armarios Primo Sliding Doors, las puertas están realizadas con paneles en chapa microperforada con material fonoabsorbente en la parte posterior. Una solución que combina la función de contención a la de reducción del reverbero y del ruido en el interior del ambiente de trabajo.



Primo Sliding Doors Acoustic  
Module 1600 x 450 x 1170 H mm  
Key detail



Primo Sliding Doors Acoustic  
Module 1600 x 450 x 1170 H mm

## Primo Acoustic

Spesso nell'ufficio contemporaneo la necessità di comunicazione all'esterno e all'interno del gruppo di lavoro, produce una quantità di rumore e di riverbero nell'ambiente che influisce negativamente sulla concentrazione e sulla produttività. Gli armadi Primo Acoustic rispondono all'esigenza di un maggiore comfort acustico, grazie alle ante ed agli schienali con rivestimento in tessuto fonoassorbente. Una soluzione che permette anche di organizzare e suddividere efficacemente lo spazio e di svolgere le funzioni di contenimento e archiviazione, con un unico versatile sistema.





Primo Acoustic  
Module 1000 x 450 x 1330 H mm



Table  
1800 x 800 x 740 H mm



Primo Acoustic  
Module 1000 x 450 x 1330 H mm



Primo Acoustic  
Module 1000 x 450 x 1330 H mm

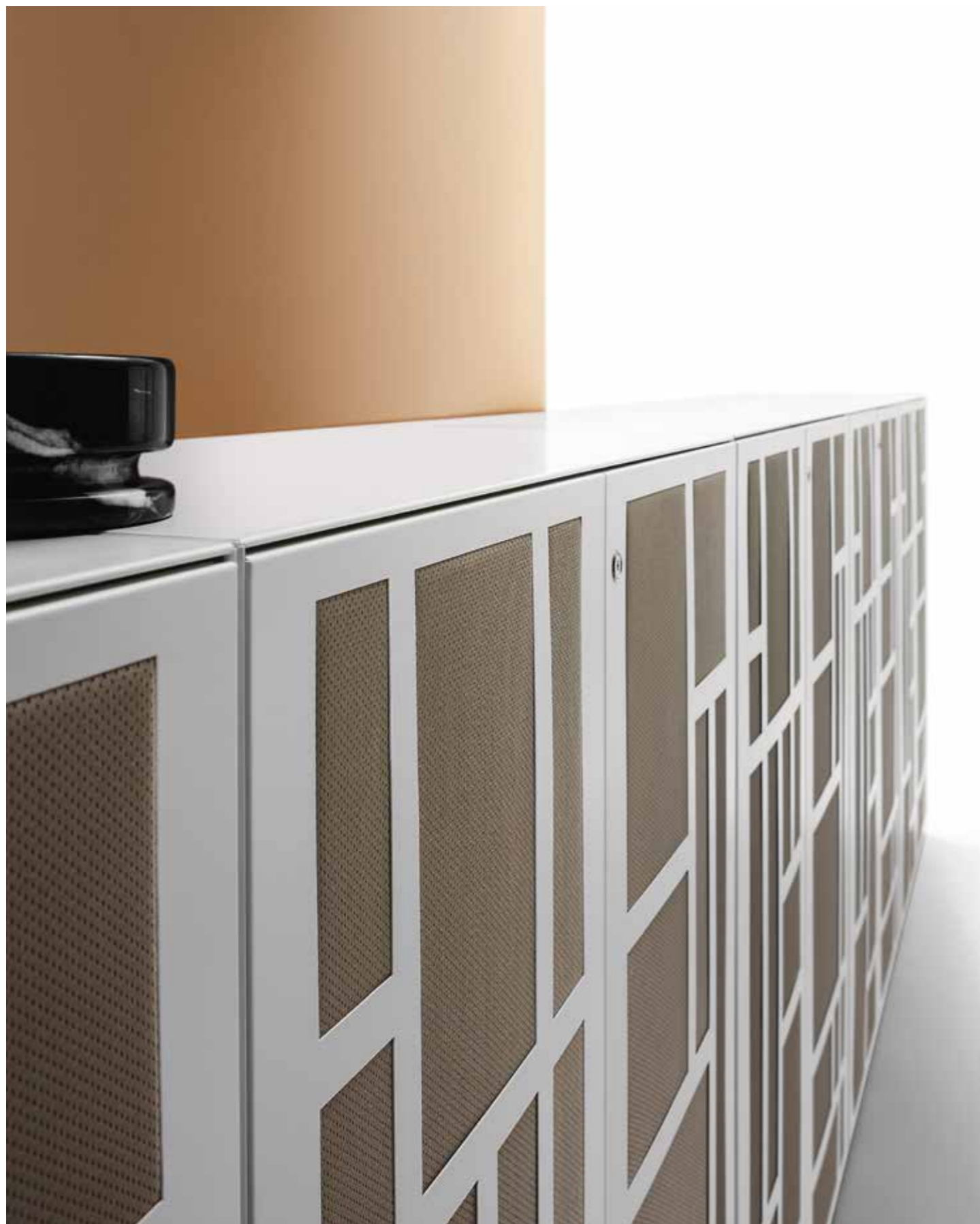

Often, in a contemporary office environment, the need to communicate outside and within the workgroup produces a lot of noise and reverberation which affects negatively both concentration and productivity. Primo Acoustic cabinets meet the need for greater acoustic comfort, thanks to the doors and backs made with sound-absorbing fabric. A solution that also allows you to efficiently organize and divide space and to carry out the storage and archiving functions using a single, versatile system.

Oft erzeugt der Kommunikationsbedarf im zeitgenössischen Büro außerhalb und innerhalb des Arbeitsteams einen Lärmpegel, der sich negativ auf die Konzentration und Leistungsfähigkeit auswirkt. Die Schränke Primo Acoustic erfüllen dank der Türen und der schalldämmenden Verkleidung die Ansprüche höchsten akustischen Komforts. Eine Lösung, die auch eine sinnvolle Organisation und Unterteilung des Raumes ermöglicht sowie die Abwicklung der Aufbewahrungs- und Archivierungsfunktionen mit einem einzigartigen und vielseitigen System.

Il y a souvent, au sein du bureau contemporain, l'exigence de communiquer à l'extérieur et à l'intérieur du groupe de travail, ce qui produit une quantité de bruit et de réverbération dans la pièce qui influence négativement la concentration de la production. Les armoires Primo Acoustic répondent à l'exigence du confort acoustique grâce aux portes et aux dossiers revêtus en tissu absorbant acoustique. Une solution qui permet aussi d'organiser et de partager efficacement l'espace et d'exercer les fonctions de rangement et d'archivage avec un seul système polyvalent.

Frecuentemente en la oficina contemporánea la necesidad de comunicación con el exterior y el interior del grupo de trabajo, produce una cantidad de ruido y de reverbero en el ambiente que influye negativamente en la concentración y en la productividad. Los armarios Primo Acoustic responden a la exigencia de un mayor confort acústico, gracias a las puertas y a los respaldos con revestimiento en tejido fonoabsorbente. Una solución que permite también organizar y subdividir eficazmente el espacio y desarrollar las funciones de contener y archivar, con un único versátil sistema.

## Primo Tambours

Realizzati in metallo con anta serrandina in materiale plastico, gli armadi Primo Tambours offrono un'efficace soluzione per il contenimento e l'organizzazione dell'ambiente di lavoro, anche in ambienti di dimensioni contenute. Il sistema di apertura consente una completa accessibilità dei vani interni, attrezzati con ripiani regolabili e accessoriabili con portacartelle estraibili. Disponibili in diverse dimensioni per ogni spazio ed esigenza.



Primo Tambours — Units  
Module 1200 x 450 x 2000 H mm

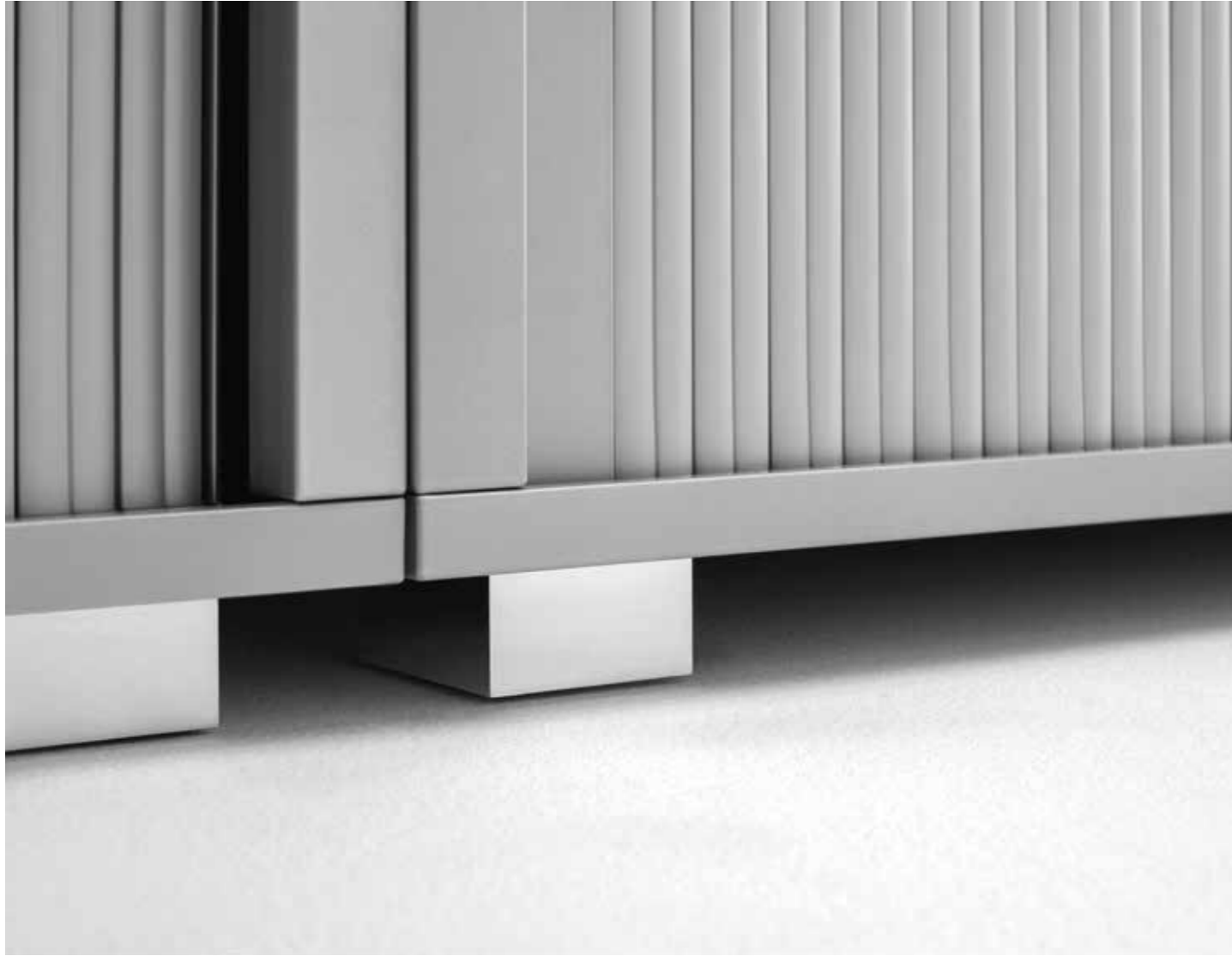

Primo Tambours - Units  
Gliders detail



Primo Tambours - Units  
Handle detail

Made of metal with a plastic shutter door, the Pimo Tambours cabinets offer an effective solution for the storage and organization within the working environment, even in small settings. The opening system allows for complete access to the interior compartments and are equipped with adjustable shelves and removable storage racks. Available in various sizes for any space and need.

Die in Metall und mit Rolladentür aus Plastik ausgeführten Schränke Primo Tambours bieten eine effiziente Lösung für die Aufbewahrung und für die Organisation des Arbeitsplatzes, auch in kleindimensionierten Bereichen. Das Öffnungssystem ermöglicht einen kompletten Zugang zu den Innenräumen, die mit verstellbaren Regalen ausgestattet sind und mit herausnehmbaren Ordnerhaltern versehen werden können. In verschiedenen Größen für jeden Raum und Anspruch erhältlich.

Réalisées en métal avec porte rideau en plastique, les armoires Primo Tambours offrent une solution efficace le rangement et l'organisation du milieu de travail, même pour les petits espaces. Le système d'ouverture permet d'accéder aux compartiments internes équipés de tablettes réglables avec la possibilité d'ajouter des porte-documents extractibles. Disponibles en plusieurs dimensions pour s'adapter aux différents espaces et exigences.

Realizados en metal con puerta a persiana en material plástico, los armarios Primo Tambours ofrecen una eficaz solución para la contención y la organización del ambiente de trabajo, incluso en ambientes de dimensiones contenidas. El sistema de apertura permite una completa accesibilidad de los espacios internos, equipados con estantes regulables y a los cuales se les puede colocar como accesorios portacarpetas extraíbles. Disponibles en diversas dimensiones para cada espacio y exigencia.



## Classic Storage

Studiati per soddisfare le esigenze di archiviazione, gli armadi metallici con ante scorrevoli Classic Storage formano un sistema modulare che può essere utilizzato anche a centro stanza per organizzare lo spazio, suddividendolo in aree con diverse funzioni. Proposti in diverse larghezze e altezze, possono essere dotati di ante in vetro temperato trasparente.



Classic Storage  
Sliding doors  
Module  
1800 x 450 x 880 H mm

Classic Storage  
Hinged door Cabinets  
Module  
1000 x 450 x 880 H mm

Tempered Glass  
Sliding Door Cabinets  
Module  
1200 x 450 x 2000 H mm

Classic Storage  
Hinged door Cabinets  
Module  
1000 x 450 x 2000 H mm





Classic Storage  
Sliding doors  
Module 1800 x 450 x 2000 H mm  
Module 1200 x 450 x 2000 H mm

Tempered Glass  
Sliding Door Cabinets  
Module 1200 x 450 x 2000 H mm  
Module 1800 x 450 x 2000 H mm



Classic Storage  
Sliding doors  
Module 1200x450x880 H mm

Tempered Glass  
Sliding Door Cabinets  
Module 1200 x 450 x 880 H mm



Classic Storage  
Sliding doors  
Module 1200 x 450 x 2000 H mm



Classic Storage  
Sliding doors  
Module 1200 x 450 x 880 H mm

Designed to meet archiving requirements, the Classic Storage metal cabinets with sliding doors form a modular system that can also be used in the centre of a room to organize space, thus dividing it into areas with various functions. They come in various widths and heights and can be equipped with transparent tempered glass doors.

Die für die Ansprüche der Archivierung entwickelten Metallschränke Classic Storage mit Schiebtüren bilden ein modulares System, das auch in der Mitte des Raumes verwendet werden kann, um den Raum zu organisieren und diesen in verschiedene Funktionsbereiche zu unterteilen. In verschiedenen Breiten und Höhen angeboten, können die Schränke mit Türen aus durchsichtigem Hartglas versehen werden.

Conçues pour satisfaire les exigences d'archivage, les armoires métalliques à portes coulissantes Classic Storage forment un système modulaire qui peut être utilisé aussi au centre de la pièce pour organiser l'espace et le partager. Disponibles en différentes largeurs et hauteurs, elles peuvent être équipées de portes en verre trempé transparent.

Estudiados para satisfacer las exigencias de archivo, los armarios metálicos con puertas corredizas Classic Storage forman un sistema modular que puede ser utilizado también en el centro de la oficina para organizar el espacio, subdividiéndolo en áreas con diversas funciones. Propuestos en diversas anchuras y alturas, pueden ser dotados de puertas de vidrio templado transparente.

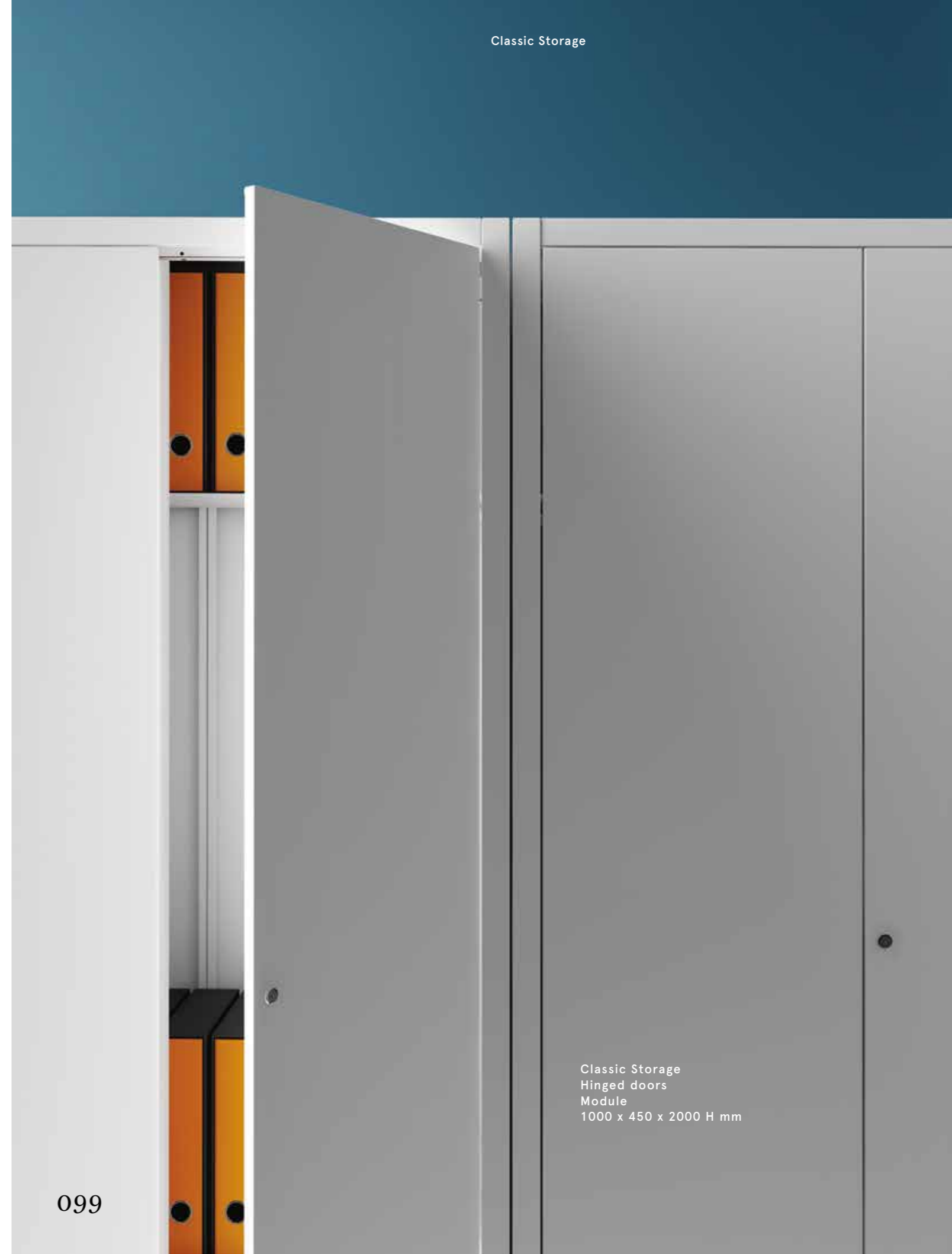

Classic Storage  
Hinged doors  
Module  
1000 x 450 x 2000 H mm



Tempered Glass  
Sliding Door Cabinets  
Module 1200 X 450 X 880 H mm



## Bookcases

Dieffebi interpreta le librerie come elementi capaci di interpretare e valorizzare gli ambienti, con un design originale e una grande flessibilità d'utilizzo. La realizzazione in acciaio o alluminio, con verniciatura a polveri, garantisce una struttura estremamente solida e stabile, mantenendo degli spessori ridotti che sottolineano l'essenzialità del design. La loro modularità permette di creare grandi o piccole composizioni, negli ambienti più diversi: dall'ufficio, agli archivi, agli spazi culturali.



Chiave di Volta – Bookcase  
Module 1046 x 344 x 2037 H mm



Primo, Sliding Doors  
Composition 1600 x 450 x 1170 H mm

Table  
1600 x 800 x 740 H mm

Chiave di Volta – Bookcase  
Module 1046 x 344 x 2037 H mm





Chiave di Volta – Bookcase  
Module 1046 x 344 x 2037 H mm



Dieffebi interprets bookcases as elements capable of interpreting and enhancing environments, with an original design and great flexibility of use. They are made in steel or aluminium, with powder coating, which guarantee an extremely solid and stable structure, while maintaining a reduced thickness which emphasizes the essence of their design. Their modularity allows them to create large or small compositions in various environments: whether it be offices, archiving areas or cultural spaces.

Dieffebi sieht die Regale als Elemente mit dem Potenzial, die Umgebung mit einem originellen Design und einer hohen Verwendungsflexibilität neu zu interpretieren und aufzuwerten. Die Ausführung in Stahl oder Aluminium mit Pulverlackierung garantiert eine extrem solide und stabile Struktur und die geringen Durchmesser unterstreichen die Essentialität des Designs. Ihre Modularität ermöglicht große und kleine Kombinationen in den verschiedensten Bereichen: vom Büro bis zum Archiv und kulturellen Umgebungen.

Dieffebi conçoit les bibliothèques comme des éléments en mesure d'interpréter et de valoriser les pièces, avec un dessin original et une grande flexibilité d'utilisation. La réalisation en acier ou en aluminium, avec revêtement par poudre, garantit une structure extrêmement solide et stable tout en maintenant des épaisseurs réduites qui soulignent l'essentiel du design. Leur modularité permet de créer de grandes ou de petites compositions dans n'importe quel type d'environnement : les bureaux, les archives, les espaces culturels.

Dieffebi interpreta las librerías como elementos capaces de interpretar y valorizar los ambientes, con un diseño original y una gran flexibilidad de uso. La realización en acero o aluminio, con pintura en polvo garantiza una estructura extremadamente sólida y estable, manteniendo espesores reducidos que resaltan la esencialidad del diseño. Su modularidad permite crear grandes o pequeñas composiciones, en los ambientes más diversos: desde la oficina, a los archivos, a los espacios culturales.

cWave – Bookcase  
2920 x 300 x 2223 H mm

DotBox Reception  
Module 800 x 410 x 400 H mm  
+ 800 x 410 x 217 H mm

cWave – Bookcase  
2920 x 300 x 2223 H mm



DotBox Reception  
Module 800 x 410 x 400 H mm  
+ 800 x 410 x 217 H mm



DotBox Reception  
Module 800 x 410 x 400 H mm  
+ 800 x 410 x 217 H mm



cWave – Bookcase  
2920 x 300 x 2223 H mm



cWave – Bookcase  
2920 x 300 x 2223 H mm

## Lockers

L'ambiente lavorativo deve prevedere anche delle soluzioni per depositare documenti, oggetti e accessori personali, mantenendo un giusto livello di privacy. Ispirati al concetto di modularità della collezione Dieffebi, i contenitori Primo Lockers sono dotati di serratura a combinazione e di fessura per inserire corrispondenza, riviste e plichi in assenza dell'utente. La loro componibilità e la scelta fra diverse dimensioni e finiture, permette di utilizzare questi contenitori per definire e organizzare lo spazio.



Primo Lockers – Units  
Module 1000 x 450 x 1330 H mm



Primo Lockers – Units  
Module 1000 x 450 x 1330 H mm

A work environment should also provide solutions for storing documents, personal objects and accessories while maintaining the right level of privacy. Inspired by Dieffebi collection's concept of modularity, the Primo Lockers containers are equipped with a combination lock and a fissure to accommodate correspondence, magazines and parcels in the absence of the user. Their modular versatility, and the various sizes and finishes to choose from, allow these containers to be used to define and organize space.

Die Arbeitsumgebung muss auch Lösungen zur Ablage von Dokumenten, Gegenständen oder persönlichen Requisiten vorsehen, um das notwendige Maß an Privatsphäre einzuhalten. Inspiriert am Konzept der Modularität der Kollektion von Dieffebi, sind die Kästen Primo Lockers mit Kombinationsschlössern und Schlitzen für Korrespondenz, Zeitschriften und Umschlägen bei Abwesenheit des Anwenders ausgestattet. Ihre Zusammensetzbarkeit und die Auswahl an verschiedenen Größen und Feinverarbeitungen ermöglicht den Einsatz dieser Kästen zur Raumdefinition und -Organisation.

Le milieu de travail prévoit aussi des solutions pour déposer des documents, les objets et les accessoires personnels tout en préservant le juste niveau de confidentialité. Inspirés au principe de modularité de la collection Dieffebi, les meubles de rangement Primo Lockers sont équipés d'une serrure à combinaison et d'une ouverture pour introduire la correspondance, les revues et les courriers séparés en l'absence de l'utilisateur. Leur modularité et le choix parmi les différentes dimensions et finitions, permettent d'utiliser ces éléments de rangement pour définir et organiser l'espace.

El ambiente laboral debe prever también soluciones para depositar documentos, objetos y accesorios personales, manteniendo un justo nivel de privacidad. Inspirados en el concepto de modularidad de la colección Dieffebi, los contenedores Primo Lockers están dotados de cerradura con combinación y fisura para introducir correspondencia, revistas y pliegos durante la ausencia del usuario. Su componibilidad y la selección entre diversas dimensiones y acabados, permite utilizar estos contenedores para definir y organizar el espacio.





Primo Modular Elements  
Unit with Itair System  
Module 1000 x 450 x 420 H mm



Primo Lockers – Units  
Module 1000 x 450 x 1330 H mm  
Lock 4 Digit detail



Primo Lockers - Units  
Module 1000 x 450 x 1330 H mm



Primo Lockers - Units  
Module 1000 x 450 x 1330 H mm  
Melamine doors



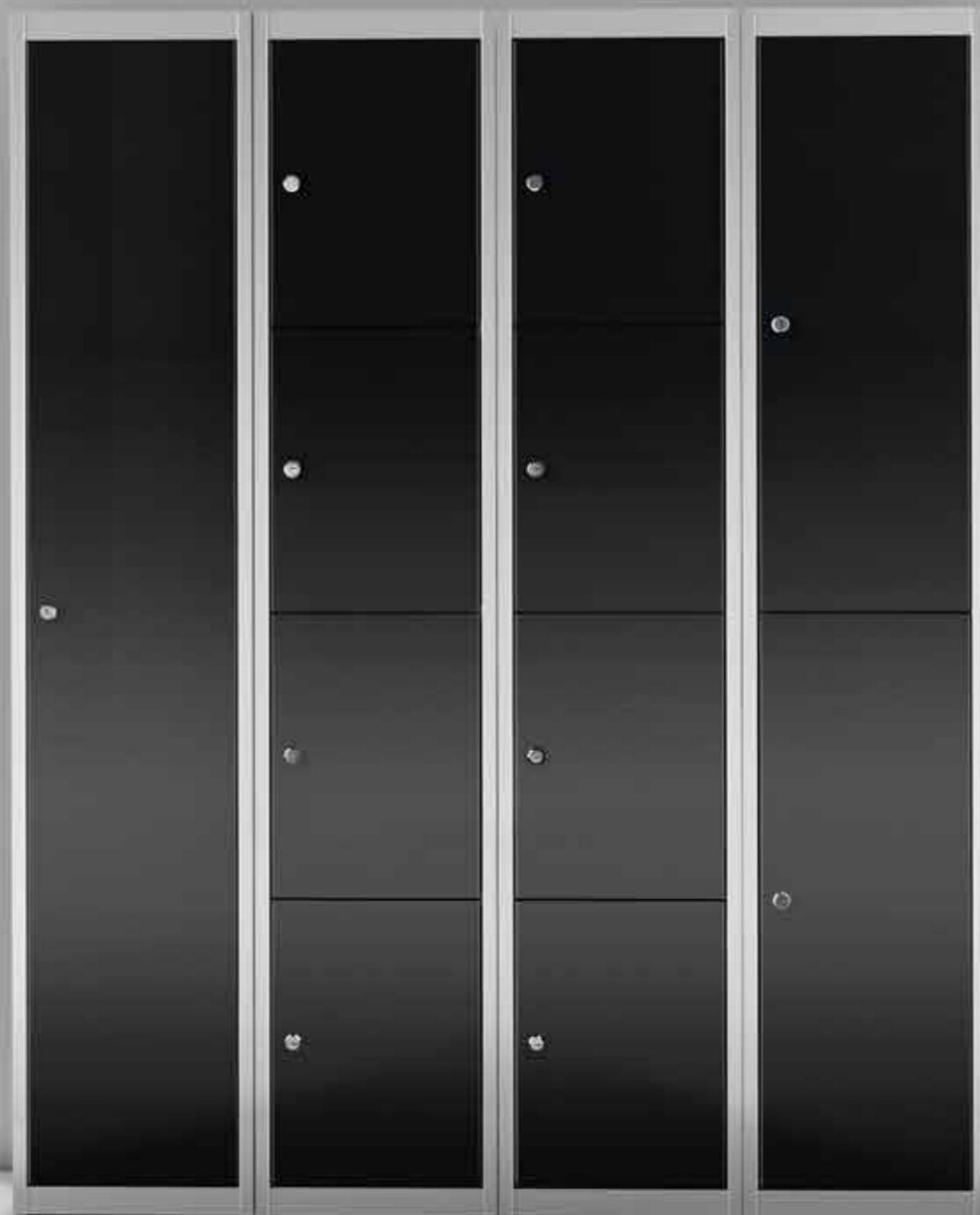

Trendline - Lockers  
Module 360 x 500 x 1800 H mm

Trendline Silver è un programma modulare di armadi dedicati in maniera specifica all'ambiente ufficio. Realizzati in robusta lamiera metallica con verniciatura a polveri, in diverse altezze, sono dotati di ante battenti singole o multiple con serratura e fori posteriori per l'aerazione.

Trendline Silver is a modular program of cabinets dedicated specifically to the office environment. They are made of robust sheet metal with powder coating, in various lengths, and have single or multiple swing doors with locks and holes in the rear for ventilation.

Trendline Silver ist ein modulares Schrankprogramm, das speziell der Büroumgebung gewidmet ist. Aus robustem Metallblech mit Pulverlackierung und in verschiedenen Höhen sind die Schränke mit ein- oder mehrteiligen Flügeltüren mit Schloss und rückseitigen Entlüftungslöchern ausgestattet.

Trendline Silver est un programme modulaire d'armoires dédiées spécialement aux bureaux. Elles sont réalisées en tôle métallique résistante, avec revêtement par poudre, en différentes hauteurs et équipées de portes battantes simples ou multiples avec serrure et trous postérieurs pour l'aération.

Trendline Silver es un programa modular de armarios dedicados de manera específica al ambiente oficina. Realizados en robusta chapa metálica con pintura en polvos, en diversas alturas, están dotados de puertas batientes sencillas o múltiples con cerradura y orificios posteriores para ventilación





Steel Design

## Personal Storage

Realizzati in metallo e dotati di ruote, i contenitori CBox si presentano come un'esperienza di design multisensoriale. Le loro forme morbide sono infatti personalizzabili con una gamma cromatica che comprende 9 colori diversi, a loro volta abbinati a diverse fragranze all'interno dei cassetti. La maniglia a scomparsa sui frontali rappresenta allo stesso tempo un dettaglio funzionale ed un segno grafico. Il top può essere completato con un sottile ma comodo cuscino, rivestito in tessuto, che trasforma il contenitore in una seduta.

CBox – Personal Storage  
450 x 450 x 475 H mm  
with cushion



CBox – Personal Storage  
450 x 450 x 475 H mm  
850 x 450 x 475 H mm



CBox – Personal Storage  
450 x 450 x 475 H mm  
with cushion

The CBox containers, which are made of metal and come with wheels, are presented as a multi-sensory design experience. Their soft shapes are in fact customizable with a colour range that includes 9 different colours that can be combined with the various fragrances inside the drawers. The retractable handle on the front panels is both a functional detail and a graphic sign. The top can be completed with a slim but comfortable, fabric-coated pillow which transforms the container into a seat.

Aus Metall und mit Rädern ausgestattet, präsentieren sich die Kästen CBox als multisensorisches Designerlebnis. Die weichen Formen sind mit einer Palette von 9 verschiedenen Farben persönlich gestaltbar und können mit verschiedenen Düften im Inneren der Fächer kombiniert werden. Der verdeckte Griff auf der Vorderseite ist gleichzeitig ein funktionelles Detail und grafisches Element. Der Oberteil kann mit einem dünnen aber bequemen Polster mit Stoffüberzug ergänzt werden, der den Kasten in einen Sitz verwandelt.

Les meubles de rangement à roulettes CBox sont réalisés en métal pour une expérience de design multi-sensorielle. En effet, leurs formes souples peuvent être personnalisées avec une gamme de 9 couleurs différentes, à leur tour assorties aux différentes fragrances à l'intérieur des tiroirs. La poignée escamotable représente un détail fonctionnel et une caractéristique graphique. Le plan peut être complété par un confortable coussin, revêtu en tissu, qui transforme le meuble en une assise.

Realizados en metal dotados de ruedas, los contenedores CBox se presentan como una experiencia de diseño multisensorial. Sus formas suaves son de hecho personalizables con una gama cromática que comprende 9 colores diversos, a su vez combinados a diversas fragancias en el interior de los cajones. El tirador escondido en los frontales representa al mismo tiempo un detalle funcional y un signo gráfico. La parte superior puede ser completada con un sutil pero cómodo cojín, revestido en tejido, que transforma el contenedor en un asiento.



Universal Quick – Personal Storage  
420 x 533 x 505 H mm

Universal Quick – Personal Storage  
320 x 533 x 505 H mm

Caratterizzati da un design essenziale che si presta agli ambienti ed alle situazioni più diverse, i contenitori metallici Universal Quick possono dare vita a molteplici composizioni modulari e abbinamenti cromatici tra i frontali dei cassetti. Questi ultimi sono attrezzabili internamente con accessori per ogni esigenza. Una soluzione veloce e di qualità per integrare sistemi di arredo ufficio già esistenti oppure risolvere spazi di servizio o di transito.

The Universal Quick metal containers feature an essential design that fits into various environments and situations; they're ideal for multiple modular compositions and colour combinations on the front of the drawers. The drawers can be equipped internally with accessories for every need. A fast and quality solution for integrating existing office furniture systems or solving service or transit spaces.

Dank ihres essentiellen Designs, das sich für verschiedenste Umgebungen und Situationen eignet, ermöglichen die Metallkästen Universal Quick unzählige modulare Zusammenstellungen und Farbkombinationen an den Vorderseiten der Fächer. Diese sind im Inneren mit Accessoires für jegliche Ansprüche ausstattbar. Eine schnelle und qualitative Lösung, um bereits vorhandene Büroeinrichtungen zu ergänzen oder um Arbeits- und Durchgangsbereiche aufzulösen.

Caractérisés par un dessin essentiel qui se prête aux environnements et aux situations les plus variées, les meubles de rangement métalliques Universal Quick permettent de créer de nombreuses compositions modulaires et d'assortiment de couleurs entre les façades des tiroirs. Ces derniers peuvent être équipés à l'intérieur d'accessoires pour satisfaire chaque exigence de rangement. Une solution rapide et de haute qualité pour enrichir les systèmes d'ameublement des bureaux déjà existants ou pour compléter les espaces de service ou de passage.

Caracterizados por un diseño esencial que se presta a los ambientes y a las situaciones más diversas, los contenedores metálicos Universal Quick pueden dar vida a múltiples composiciones modulares y combinaciones cromáticas entre los frontales de los cajones. Estos últimos se pueden equipar internamente con accesorios para cada exigencia. Una solución veloz y de calidad para integrar sistemas de amoblado ya existentes o resolver esos espacios de servicio o de transito.

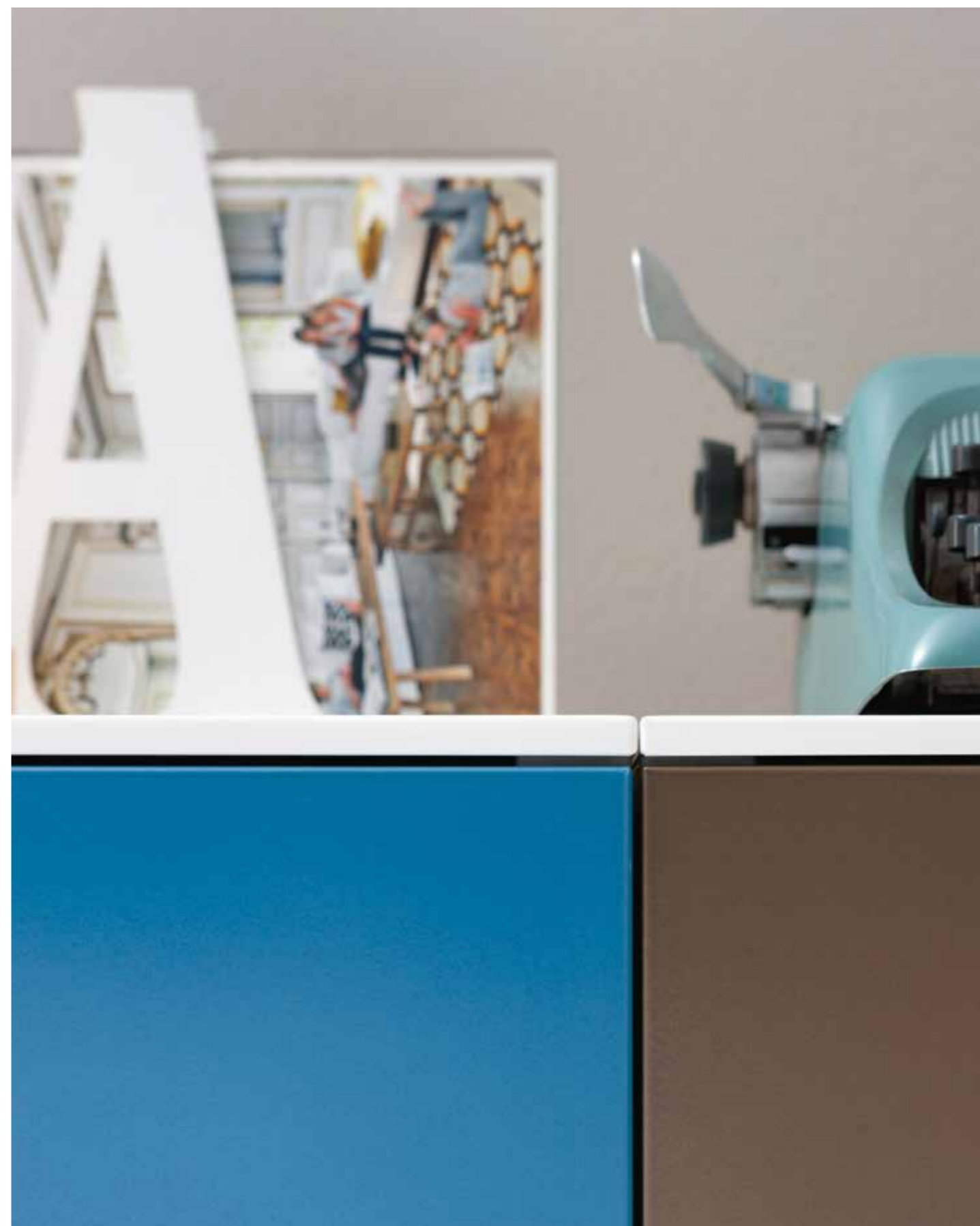





Universal 420 - Personal Storage  
420 x 533 x 555 H mm



Mia Ped – Personal storage  
427 x 529 x 460 H mm

Dinamico e compatto, Mia Ped è un contenitore personale che può essere completamente configurato dall'utente, pensato per accogliere i moderni strumenti di lavoro dello "smart office" e trasformabile anche in seduta. Realizzato in metallo e dotato di ruote a scomparsa, si presenta in diversi colori di tendenza e può essere utilizzato sia singolarmente che in composizioni multiple.

Dynamic and compact, Mia Ped is a personal container that can be completely arranged by the user. It is designed to accommodate modern "smart office" working tools and can also be transformed into a seat. It is made of metal and is equipped with retractable wheels. It comes in various trendy colours and can be used both individually and in multiple compositions.

Dynamisch und kompakt, kann der persönliche Kasten Mia Ped vollständig vom Benutzer konfiguriert werden und wurde für die Organisation der Arbeitsinstrumente des „Smart Office“ konzipiert und lässt sich außerdem in einen Sitz verwandeln. In Metall ausgeführt und mit verdeckten Rädern ausgestattet, erscheint der Kasten in verschiedenen trendigen Farben und kann sowohl einzeln als auch in mehrteiligen Kombinationen verwendet werden.

Dynamique et compact, Mia Ped est un meuble de rangement pour les effets personnels que l'utilisateur peut personnaliser à son gré, il est conçu pour accueillir les instruments modernes de travail du « bureau intelligent » et peut être transformé en une assise. Réalisé en métal et équipé de roues escamotables, il est disponible en différentes couleurs très tendance et peut être utilisé seul ou combine.

Dinámico y compacto, Mia Ped es un contenedor personal que puede ser completamente configurado por el usuario, pensado para acoger los modernos instrumentos del trabajo de la "oficina inteligente" y transformable también en asiento. Realizado en metal y dotado de ruedas escondidas, se presenta en diversos colores de tendencia y puede ser utilizado tanto de modo individual como en composiciones múltiples.



Mia Ped – Personal storage  
427 x 529 x 460 H mm





Mia Ped – Personal storage  
427 x 529 x 460 H mm

Creata in maniera specifica per gli ambienti ufficio, Professional è una famiglia di cassettiere metalliche con elevati criteri di qualità e funzionalità. Realizzate con lamiera di forte spessore, sono dotate di pannello fonoassorbente interno, classificatore e cassetto con porta cancelleria sagomata, cassette a estrazione totale con divisori interni e sistemi di sicurezza anti ribaltamento.

Created specifically for office environments, Professional is a series of metal drawer units with high quality and functionality standards. Made of thick sheet metal, they are equipped with an internal sound absorbing panel, a filing cabinet and drawer with fitted stationary tray, fully removable drawers with internal dividers and anti-tipping security systems.

Professional wurde speziell für Bürobereiche entworfen und ist eine Familie von hochwertigen Metallkommoden mit hoher Funktionalität. Die Kommoden bestehen aus dickem Blech und sind im Inneren mit schalldämmenden Platten ausgestattet; Aktenschrank und profilierte Büroschublade, vollständig herausziehbare Laden mit Unterteilungen im Inneren und Kippschutzsystem.

Créée spécialement pour les bureaux, Professional est une famille de caissons à tiroirs métalliques aux critères de qualité et fonctionnalités très élevées. Réalisés en tôle épaisse, ils sont équipés de panneau absorbant acoustique interne, classeurs et tiroirs avec porte-fournitures, tiroir complètement extractible avec cloison interne et systèmes de sécurité anti-renversement.

Creada de manera específica para los ambientes oficina Professional es una familia de cajoneras metálicas con elevados criterios de calidad y funcionalidad. Realizadas con chapa de fuerte espesor, están dotadas de panel fonoabsorbente interno, clasificador y cajón porta materiales de oficina perfilado, cajones de extracción total con divisores internos y sistemas de seguridad anti vuelco.



Professional – Personal Storage  
430 x 581 x 563 H mm

## Vertical file

Vertical File è la soluzione ideale per ottimizzare e condividere lo spazio dedicato all'archiviazione, con un sistema che si integra facilmente con qualsiasi postazione di lavoro. I moduli si sviluppano in verticale e possono essere utilizzati anche come separatori fra due scrivanie affiancate, oppure essere utilizzati come piani da appoggio e di servizio. Gli elementi Vertical File possono essere completati da ulteriori moduli sovrapposti, con chiusura a serrandina oppure a giorno, per soddisfare ogni esigenza di contenimento in maniera personalizzata.

Vertical File - Tower Table  
Design Takiro Yuta  
Module 420 x 800 x 1100 H mm



Table  
1600 x 800 x 740 H mm



Vertical File – Tower Table  
420 x 800 x 1100 H mm

Vertical File – Tower Table  
420 x 800 x 1400 H mm

Vertical File – Tower Table  
420 x 800 x 710 H mm



Table  
1600 x 800 x 740 H mm



Vertical File is the ideal solution to optimize and share archiving space, with a system that easily integrates with any workstation. The modules are arranged vertically and can also be used as separators between two desks, or they can be used as shelves and service tops. Vertical File elements can be complemented by additional superimposed modules, with a small shutter closure or left open, to meet any storage need in a personalized manner.

Vertical File ist eine ideale Lösung zur Optimierung und Aufteilung des Archivierungsbereiches, mit einem System, das sich leicht mit jedem Arbeitsplatz verbindet. Die Module stehen vertikal und können auch als Unterteilungen zwischen zwei nebenstehenden Schreibtischen verwendet werden, oder als Ablage- und Arbeitsflächen. Die Vertical File Elemente können mit weiteren Kastenaufsätzen erweitert werden, mit Rolladenverschluss oder offen, um jegliche Aufbewahrungsanforderung individuell zu erfüllen.

Vertical File est la solution idéale pour optimiser et partager l'espace dédié à l'archivage avec un système qui s'adapte parfaitement à n'importe quel environnement de travail. Les modules se développent verticalement et peuvent être utilisés aussi comme cloison entre deux bureaux ou comme plan d'appui et de service. Les éléments Vertical File peuvent être complétés par d'autres modules superposés avec fermeture à rideau ou ouverts pour satisfaire les exigences de rangement personnalisées.

Vertical File es la solución ideal para optimizar y compartir el espacio dedicado al archivo, con un sistema que se integra fácilmente con cualquier posición de trabajo. Los módulos se desarrollan en vertical y pueden ser utilizados también como separadores entre dos escritorios flanqueados, o ser utilizados como tableros de apoyo y de servicio. Los elementos Vertical File pueden ser completados por adicionales módulos sobrepuestos, con cierre a persiana o abiertos, para satisfacer toda exigencia de contención de manera personalizada.



Vertical File – Tower Table  
420 x 800 x 1100 H mm

# Technical pages

# Collection

## Products

### DotBox

- 162 DotBox Evolution
- 164 DotBox

### Primo

- 168 Primo 1000
- 169 Primo Acoustic
- 170 Primo 800
- 171 Primo Sliding Doors
- 171 Primo Sliding Doors with Flush Front
- 172 Primo Sliding Doors Acoustic
- 172 Primo Tambours

### Classic Storage

- 173 Sliding Door Cabinets
- 173 Hinged Door Cabinets
- 173 Tempered Glass Sliding Door Cabinets

### Bookcases

- 174 Chiave di Volta
- 175 CWave

### Lockers

- 176 Primo Lockers
- 176 Trendline Silver

### Personal Storage

- 179 CBox
- 179 Universal Quick
- 181 Mia Ped
- 181 Professional
- 182 Vertical File

# DotBox

DotBox Evolution  
DotBox

DotBox Evolution  
Table

L 1600  
P 800  
H 740

DotBox Evolution  
Units

L 800  
P 410  
H 400/513/740

Corner  
Compositions

L 800  
P 410  
H 513/740

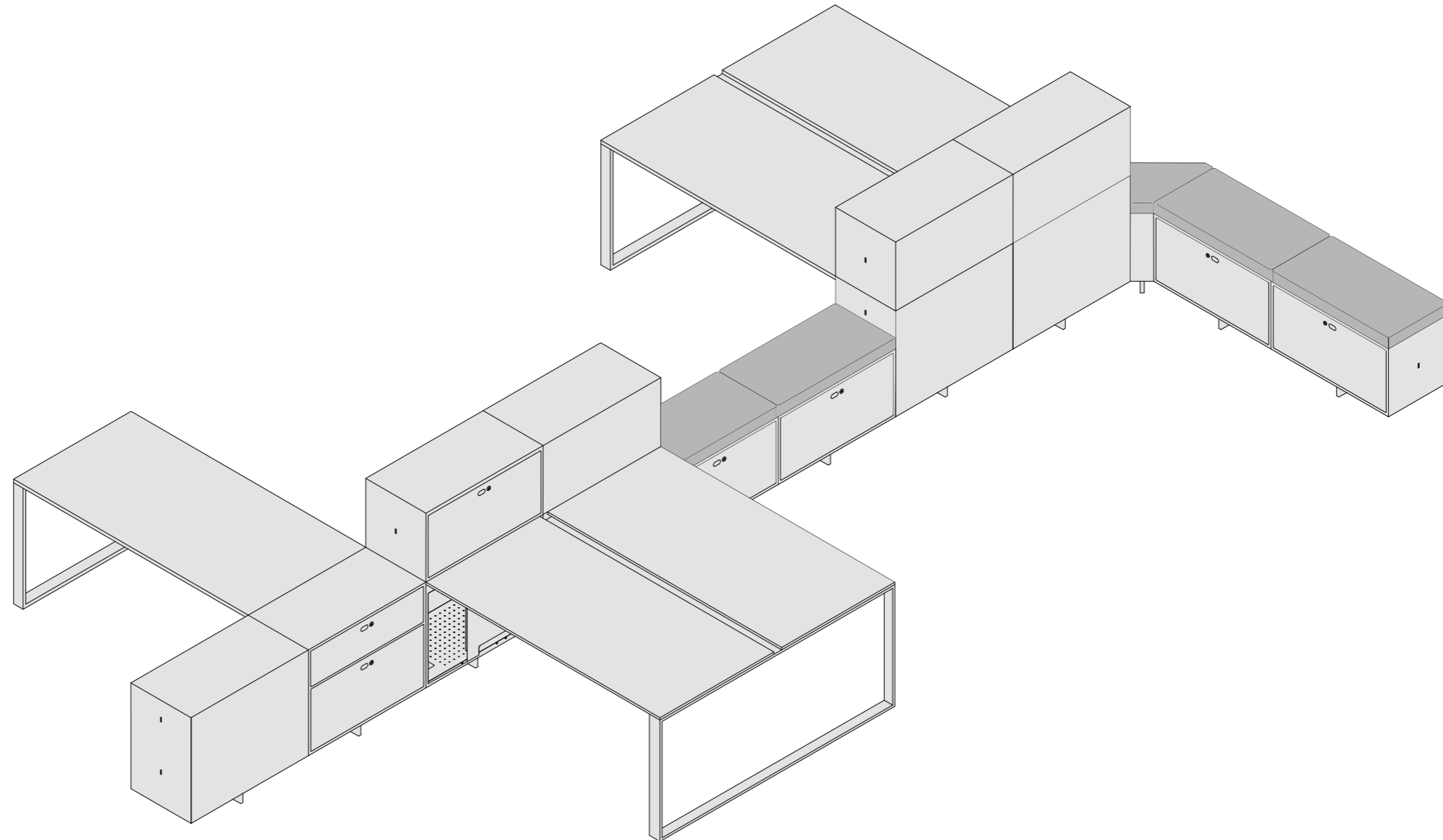

# DotBox

DotBox Evolution  
DotBox

DotBox  
Compositions

Modules  
L 800  
P 410  
H 513/913

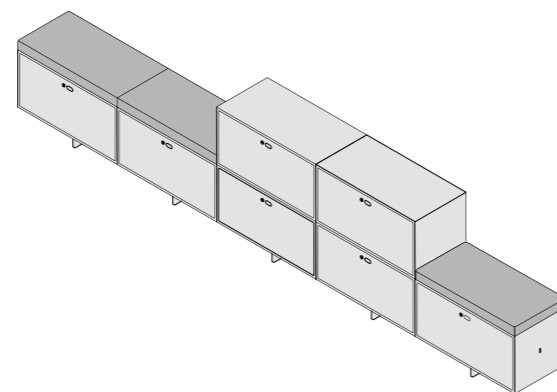

DotBox Evolution  
Table

L 1600  
P 800  
H 740

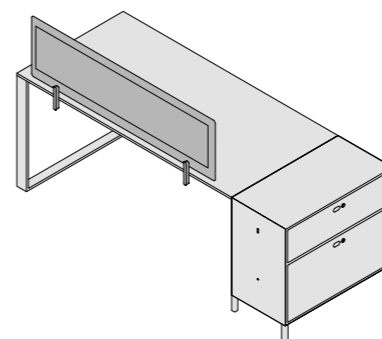

DotBox Evolution  
Table

L 1600  
P 1600  
H 740

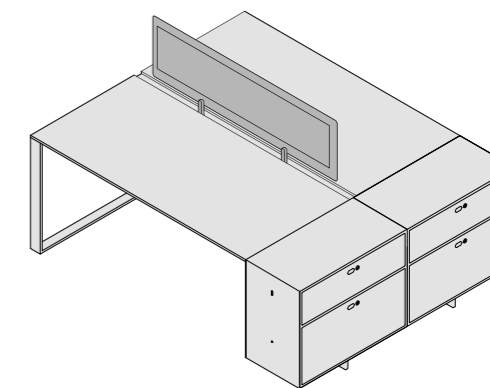

DotBox Evolution  
Table

L 1600  
P 800  
H 740

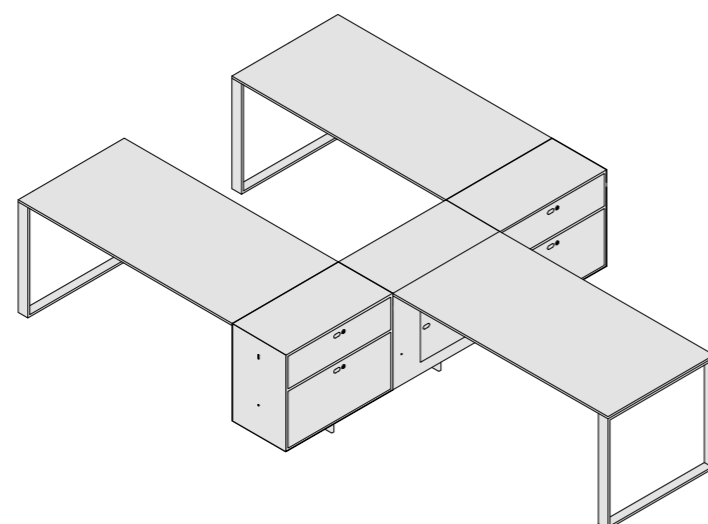

DotBox Evolution  
Table

L 1600  
P 1600  
H 740

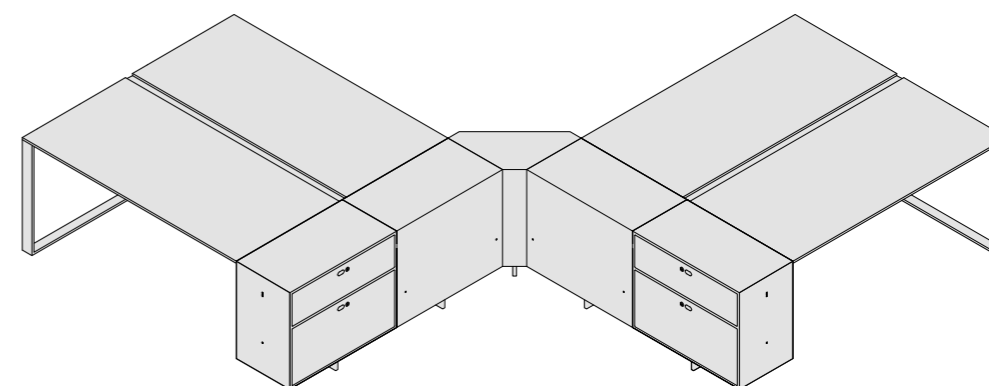

# DotBox

DotBox Evolution  
DotBox

## DotBox – Units

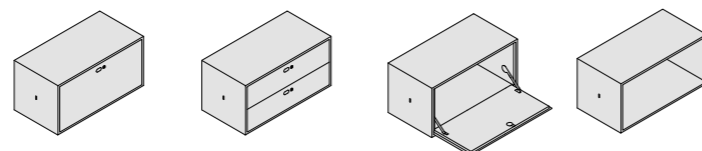

L 800  
P 410  
H 400/413

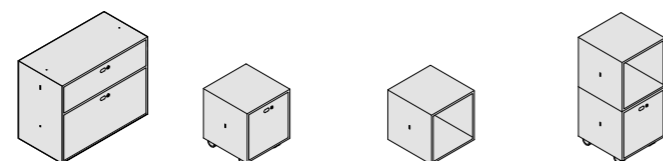

L 800  
P 410  
H 627/740

L 400  
P 410  
H 470

L 400  
P 410  
H 400/413

L 400  
P 410  
H 870

## DotBox Evolution – Units

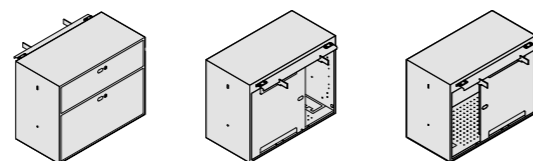

L 800  
P 410  
H 627

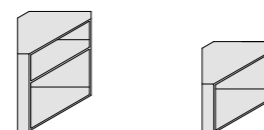

L 410  
H 627

L 410  
H 400

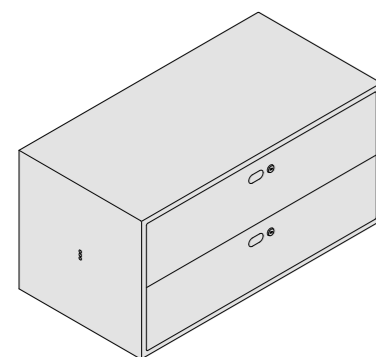

## DotBox – Unit 1-2 air device

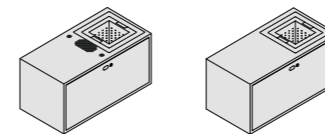

L 800  
P 410  
H 400/413

## DotBox – Unit 1-2 air and music devices

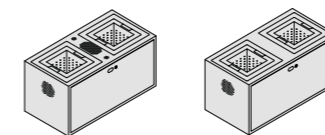

L 800  
P 410  
H 400/413

## DotBox – Open unit with shelf

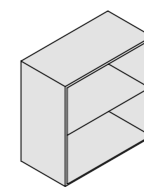

L 800  
P 410  
H 800/813

## DotBox – Unit with sliding door perspex

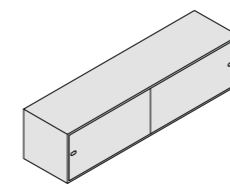

L 1600  
P 410  
H 400/413

## Single tables

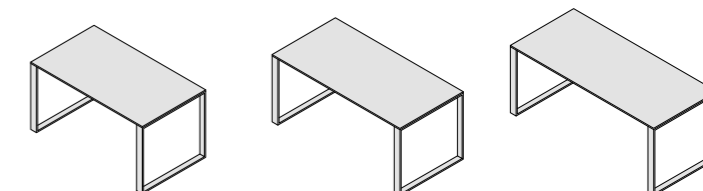

L 1400  
P 800  
H 740

L 1600  
P 800  
H 740

L 1800  
P 800  
H 740

## Double tables

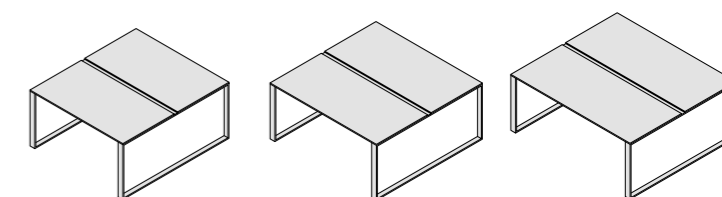

L 1400  
P 1600  
H 740

L 1600  
P 1600  
H 740

L 1800  
P 1600  
H 740

## Acoustic fabric panels



L 1370  
P 30  
H 390

L 1570  
P 30  
H 390

# Primo

- Primo 1000 Cabinets
- Primo 1000 Open Cabinets
- Primo 1000 Melamine Doors
- Primo 1000 Acoustic
- Primo 1000 Laterals
- Primo 1000 Combi
- Primo 1000 Modular Elements
- Primo Recycling

## Primo 1000 Cabinets

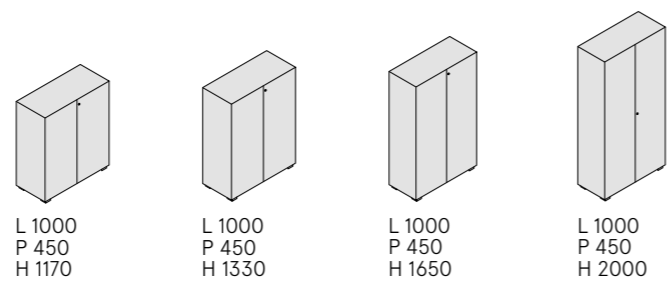
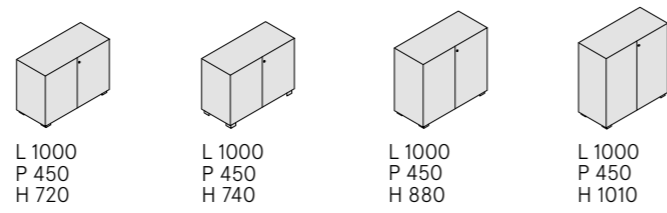

## Primo 1000 Open Cabinets

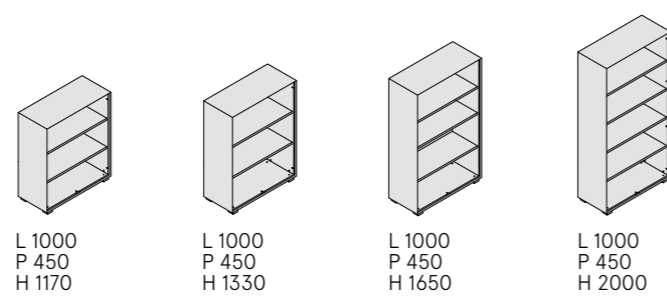

## Primo 1000 Melamine Doors

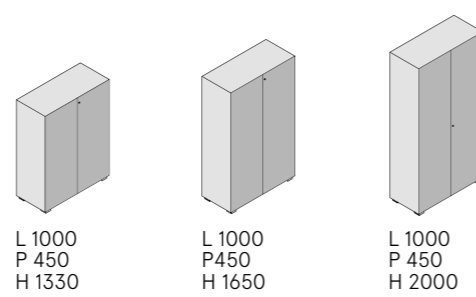

## Primo 1000 Acoustic

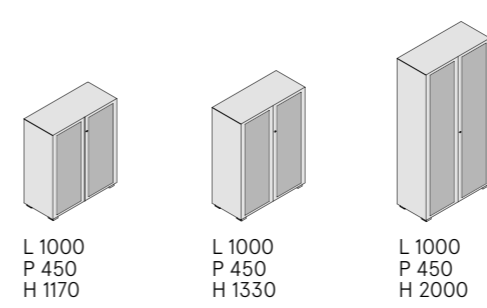
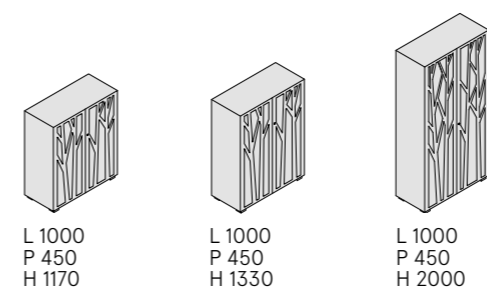

## Primo 1000 Laterals

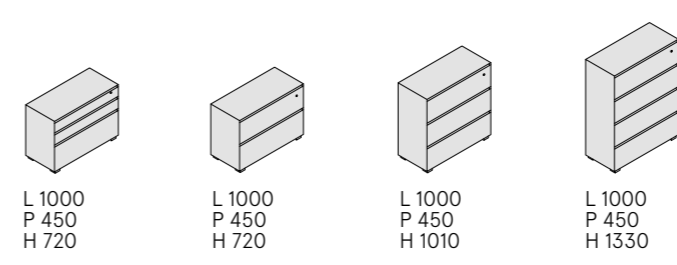

## Primo 1000 Combi

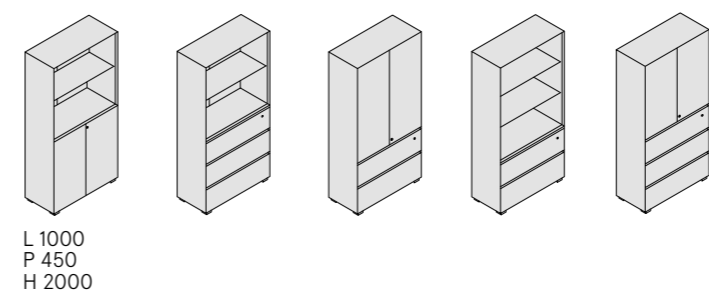

## Primo 1000 Modular Elements

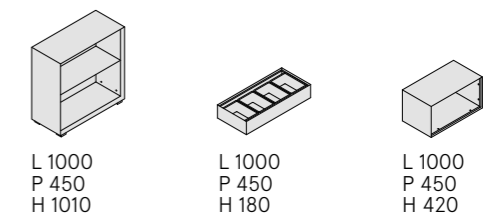
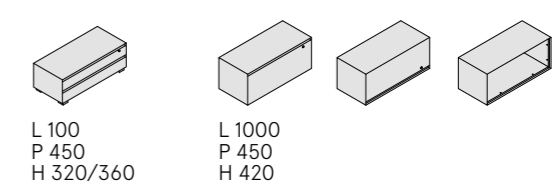

## Primo Recycling

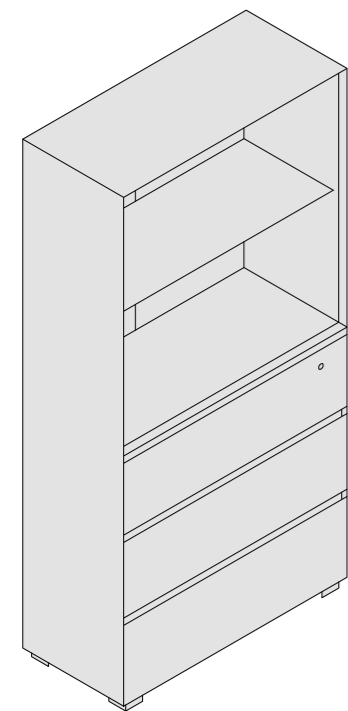
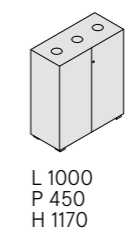

# Primo

- Primo 800 Cabinets
- Primo 800 Open Cabinets
- Primo 800 Laterals
- Primo 800 Modulares Elements
- Nice Ped
- Primo Sliding Doors
- Primo Sliding Doors with Flush Fronts

## Primo 800 Cabinets

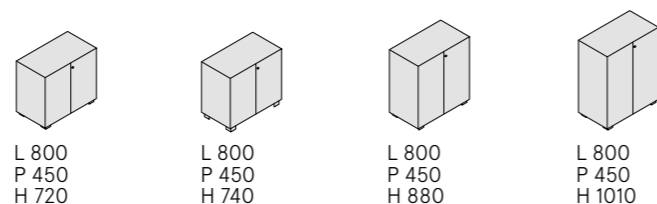

L 800  
P 450  
H 720

L 800  
P 450  
H 740

L 800  
P 450  
H 880

L 800  
P 450  
H 1010

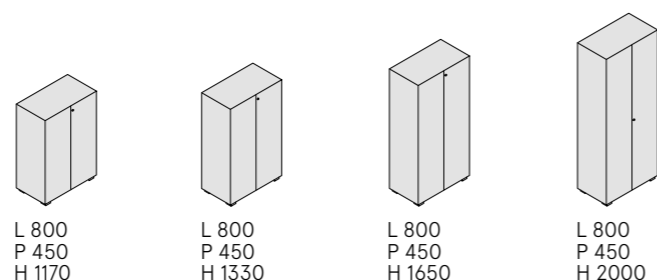

L 800  
P 450  
H 1170

L 800  
P 450  
H 1330

L 800  
P 450  
H 1650

L 800  
P 450  
H 2000

## Primo 800 Open Cabinets

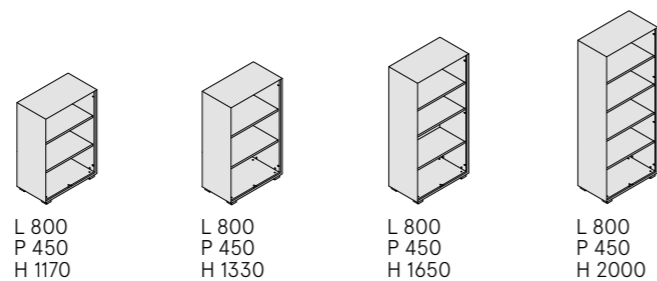

L 800  
P 450  
H 1170

L 800  
P 450  
H 1330

L 800  
P 450  
H 1650

L 800  
P 450  
H 2000

## Primo 800 Laterals

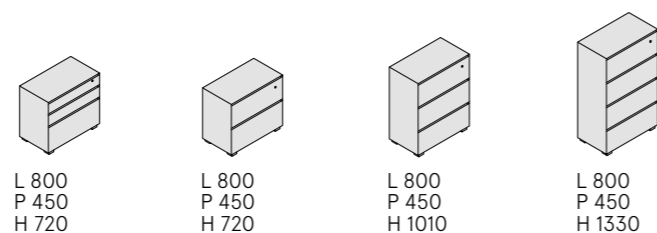

L 800  
P 450  
H 720

L 800  
P 450  
H 720

L 800  
P 450  
H 1010

L 800  
P 450  
H 1330

## Primo 800 Modulares Elements

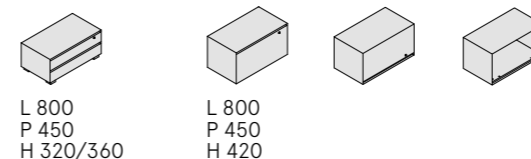

L 800  
P 450  
H 320/360

L 800  
P 450  
H 420

L 800  
P 450  
H 420

L 800  
P 450  
H 420

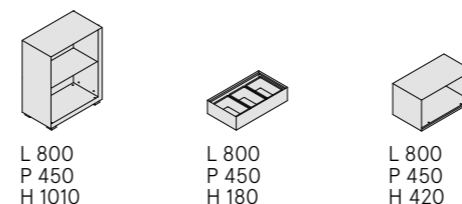

L 800  
P 450  
H 1010

L 800  
P 450  
H 180

L 800  
P 450  
H 420

## Nice Ped

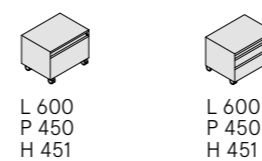

L 600  
P 450  
H 451

L 600  
P 450  
H 451

## Primo Sliding Doors

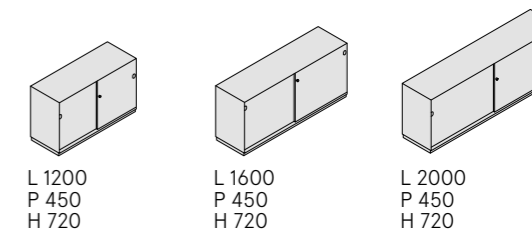

L 1200  
P 450  
H 720

L 1600  
P 450  
H 720

L 2000  
P 450  
H 720

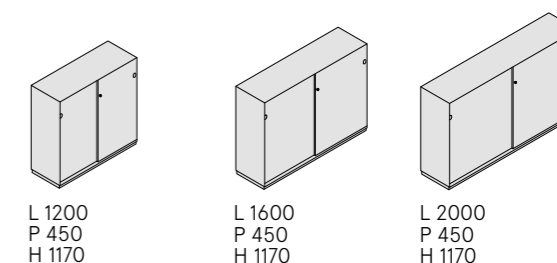

L 1200  
P 450  
H 1170

L 1600  
P 450  
H 1170

L 2000  
P 450  
H 1170

## Primo Sliding Doors with Flush Fronts

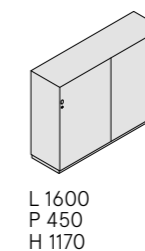

L 1600  
P 450  
H 1170

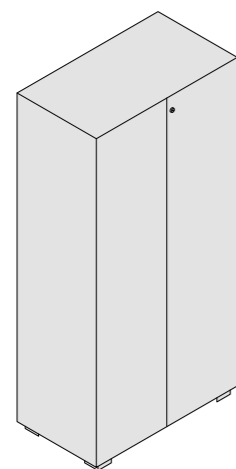

# Primo

Primo Sliding Doors Acoustic

Primo Tambours

## Primo Sliding Doors Acoustic

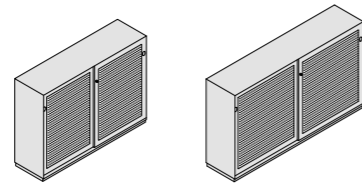

L 1600  
P 450  
H 1170

L 2000  
P 450  
H 1170

## Primo Tambours

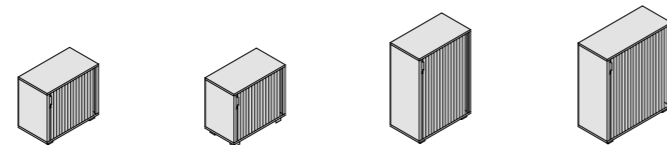

L 800  
P 450  
H 720

L 800  
P 450  
H 740

L 800  
P 450  
H 1170

L 1000  
P 450  
H 1170

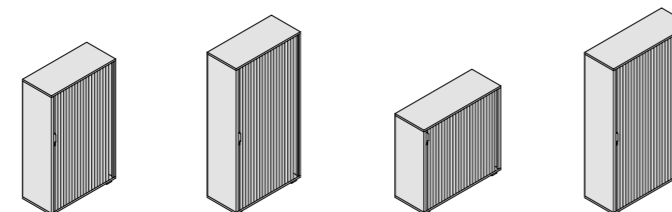

L 1000  
P 450  
H 1650

L 1000  
P 450  
H 2000

L 1200  
P 450  
H 1170

L 1200  
P 450  
H 2000

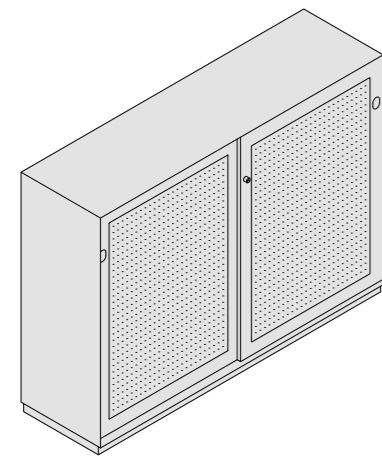

# Classic Storage

Sliding Door Cabinets

Hinged Door Cabinets

Tempered Glass Sliding Door Cabinets

Filing Cabinets

## Sliding Door Cabinets

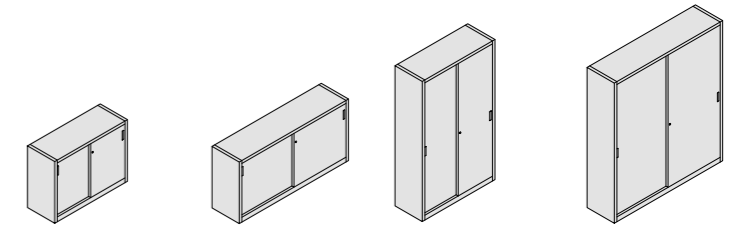

L 1200  
P 450  
H 880

L 1800  
P 450  
H 880

L 1200  
P 450  
H 2000

L 1800  
P 450  
H 2000

## Hinged Door Cabinets

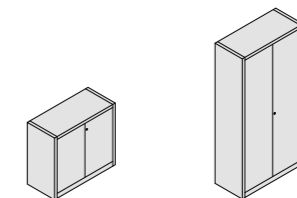

L 1000  
P 450  
H 880

L 1000  
P 450  
H 2000

## Tempered Glass Sliding door Cabinets

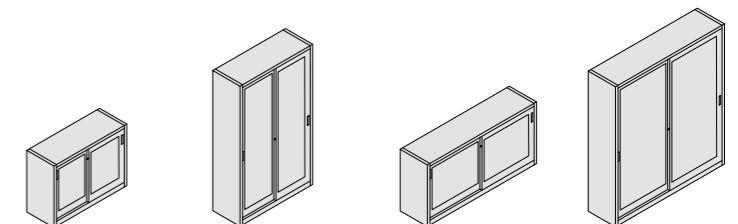

L 1200  
P 450  
H 880

L 1200  
P 450  
H 2000

L 1800  
P 450  
H 880

L 1800  
P 450  
H 2000

## Filing Cabinets

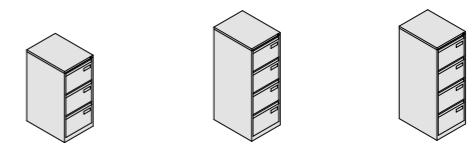

L 470  
P 622  
H 1016

L 470  
P 622  
H 1321

L 470  
P 622  
H 1321

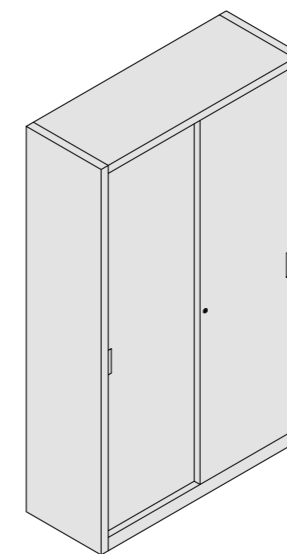



# Bookcases

Chiave di Volta

CWave

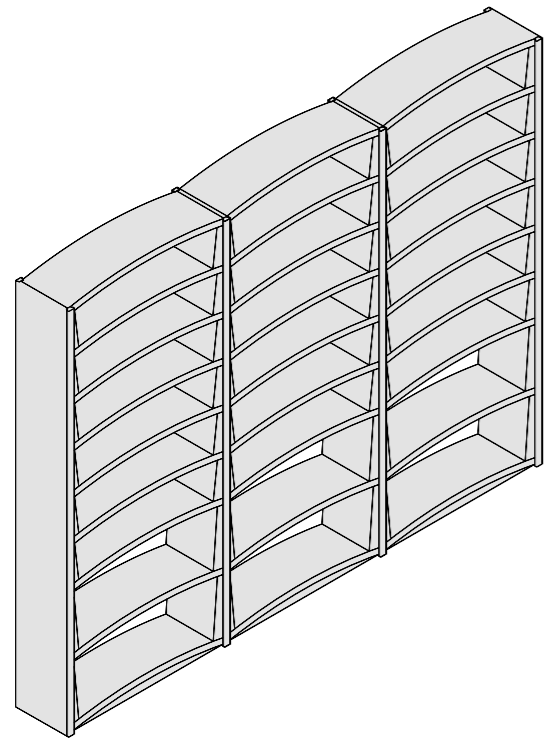

## Chiave di Volta

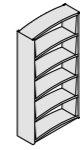

5 Shelves  
L 1046  
P 344  
H 2037

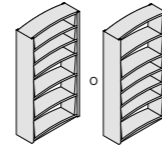

6 Shelves  
L 1046  
P 344  
H 2037

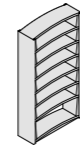

7 Shelves  
L 1046  
P 344  
H 2037

### Additional Element, H 2037

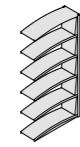

5 Shelves  
L 1046  
P 344  
H 2037

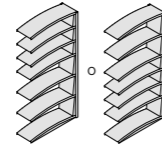

6 Shelves  
L 1046  
P 344  
H 2037

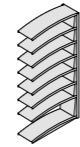

7 Shelves  
L 1046  
P 344  
H 2037

### Wall-Mounted magazine

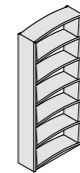

6 Shelves  
L 1046  
P 344  
H 2427

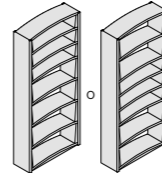

7 Shelves  
L 1046  
P 344  
H 2427

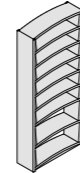

8 Shelves  
L 1046  
P 344  
H 2427

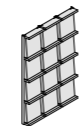

L 1035  
P 144  
H 1625

### Additional Element, H 2427

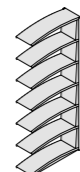

6 Shelves  
L 1046  
P 344  
H 2427

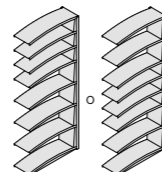

7 Shelves  
L 1046  
P 344  
H 2427

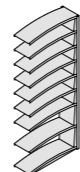

8 Shelves  
L 1046  
P 344  
H 2427

## CWave

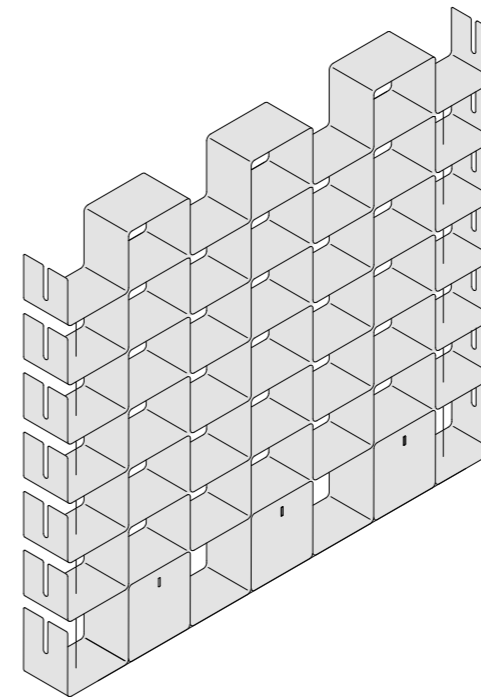

## 2 drawers

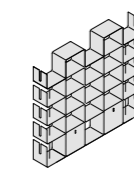

L 2086  
P 300  
H 1873

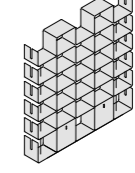

L 2086  
P 300  
H 2223

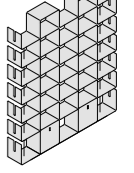

L 2086  
P 300  
H 2573

## 3 drawers

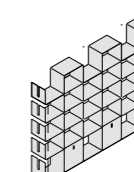

L 2920  
P 300  
H 1873

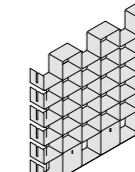

L 2920  
P 300  
H 2223

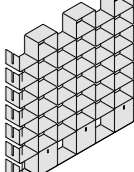

L 2920  
P 300  
H 2573

## 4 drawers

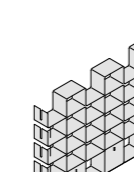

L 3754  
P 300  
H 1873

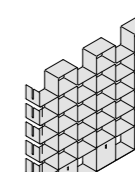

L 3754  
P 300  
H 2223

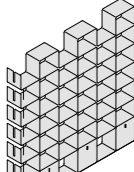

L 3754  
P 300  
H 2573

## Composition angle

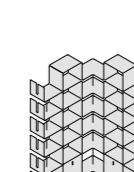

L 1372  
P 1372  
H 2223

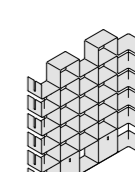

L 2206  
P 1372  
H 2223

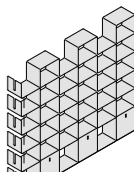

L 3041  
P 1372  
H 2223

# Lockers

Primo 1000 Lockers Melamine Doors

Primo 1000 Lockers

Trendline Silver

Personal Lockers

Monoplus

Monoplus Design

Duploplus

Hpl

Inox

Design Anta inox

Combi

## Primo 1000 Lockers Melamine Doors

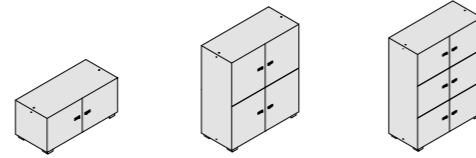

L 1000  
P 450  
H 460

L 1000  
P 450  
H 1170

L 1000  
P 450  
H 1330

## Primo 1000 Lockers

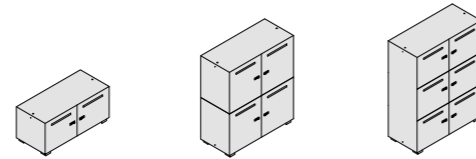

L 1000  
P 450  
H 460

L 1000  
P 450  
H 1170

L 1000  
P 450  
H 1330

## Trendline Silver

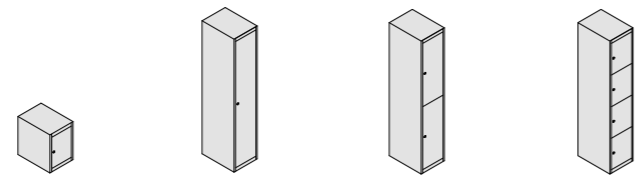

L 360  
P 500  
H 515

L 360  
P 500  
H 1800

L 360  
P 500  
H 1800

L 360  
P 500  
H 1800

## Personal Lockers

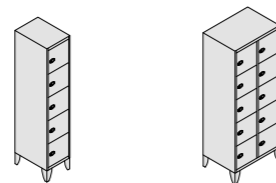

L 322  
P 500  
H 1800

L 615  
P 500  
H 1800

## Monoplus

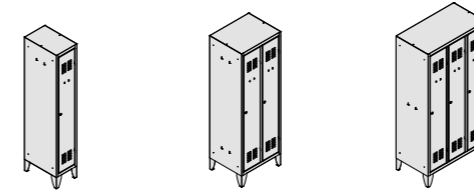

L 322  
P 500  
H 1800

L 615  
P 500  
H 1800

L 907  
P 500  
H 1800

## Monoplus Design

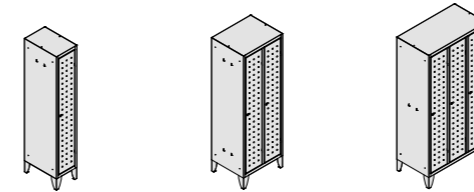

L 322  
P 500  
H 1800

L 615  
P 500  
H 1800

L 907  
P 500  
H 1800

## Duploplus

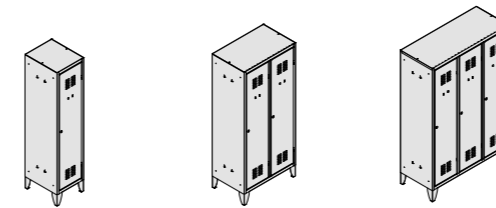

L 420  
P 500  
H 1800

L 810  
P 500  
H 1800

L 1200  
P 500  
H 1800

## Hpl

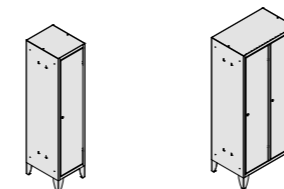

L 420  
P 500  
H 1800

L 810  
P 500  
H 1800

## Inox

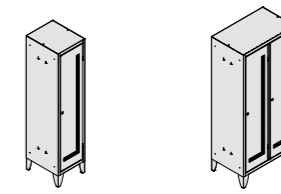

L 415  
P 500  
H 1800

L 800  
P 500  
H 1800

## Design Anta inox

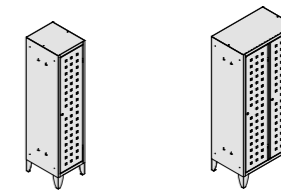

L 420  
P 500  
H 1800

L 810  
P 500  
H 1800

## Combi

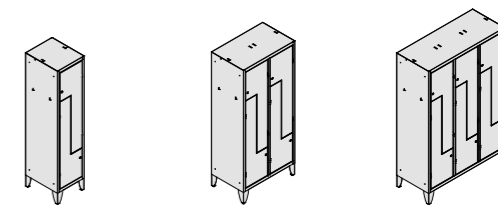

L 420  
P 500  
H 1800

L 810  
P 500  
H 1800

L 1200  
P 500  
H 1800

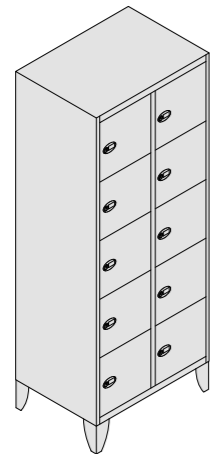

# Lockers

Multiplus  
Multiplus Design  
Multiuse Cabinets

## Multiplus



L 322  
P 500  
H 1800



L 615  
P 500  
H 1800

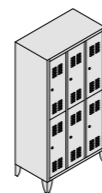

L 907  
P 500  
H 1800

## Multiplus Design

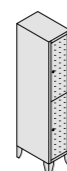

L 322  
P 500  
H 1800

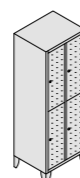

L 615  
P 500  
H 1800

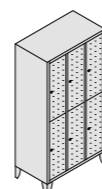

L 907  
P 500  
H 1800

## Multiuse Cabinets

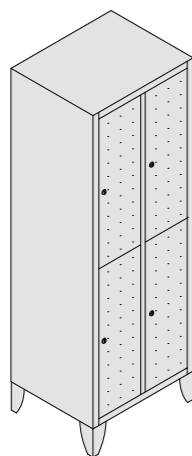

L 600  
P 400  
H 1800

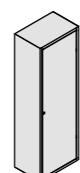

L 600  
P 400  
H 1800



L 1000  
P 400  
H 1800

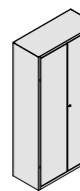

L 1000  
P 400  
H 1800

# Personal Storage

CBox  
Universal Quick 320  
Universal Quick 420  
Universal Mobile 420

## CBox



L 450  
P 450  
H 475



L 450  
P 450  
H 475

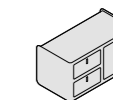

L 850  
P 450  
H 475

## Universal Quick 320



L 320  
P 533  
H 505



L 320  
P 533  
H 505

## Universal Quick 420



L 420  
P 533  
H 505



L 420  
P 533  
H 505

## Universal Mobile 420

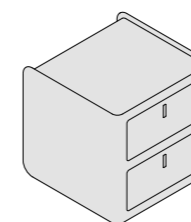

L 420  
P 533  
H 555



L 420  
P 533  
H 555



L 420  
P 533  
H 555



L 420  
P 533  
H 555

# Personal Storage

Universal Color Mobile 420

Universal Plus 420

Universal Mobile 320

Universal Free Standing

Mia Ped

Professional

Flex

Nice Ped

Bordino Ped

Inox

Pc Box

## Universal Color Mobile 420



L 420  
P 533  
H 555



L 420  
P 533  
H 555



L 420  
P 533  
H 555

## Universal Plus 420



L 420  
P 533  
H 555



L 420  
P 533  
H 555

## Universal Mobile 320



L 320  
P 533  
H 555



L 320  
P 533  
H 555

## Universal Free Standing

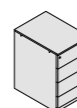

L 420  
P 583  
H 693/720

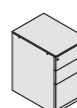

L 420  
P 583  
H 693/720

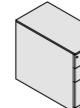

L 420  
P 790  
H 693/720

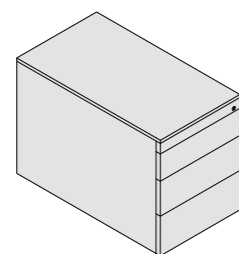

## Mia Ped



L 427  
P 529  
H 460



L 427  
P 529  
H 460



L 427  
P 529  
H 460



L 427  
P 529  
H 460

## Professional



L 430  
P 581  
H 563



L 430  
P 581  
H 563

## Nice Ped



L 600  
P 450  
H 451



L 600  
P 450  
H 451

## Bordino Ped



L 420  
P 560  
H 498



L 420  
P 560  
H 498

## Inox



L 430  
P 781  
H 563



L 430  
P 781  
H 563



L 420  
P 533  
H 555

## Flex



L 420  
P 525  
H 545



L 420  
P 525  
H 545

## Pc Box



L 240  
P 575  
H 580

# Personal Storage

Vertical file

Tidy

Vertical file

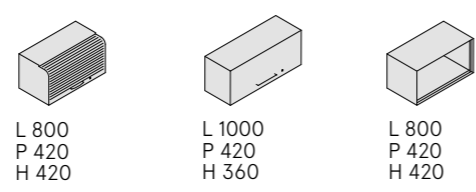
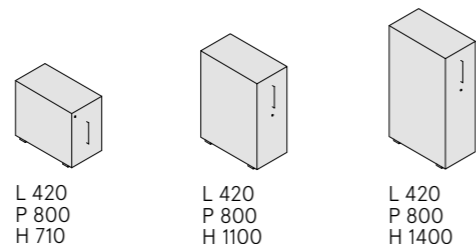

Tidy

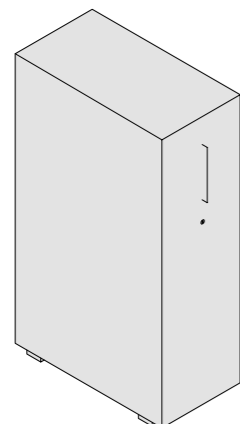
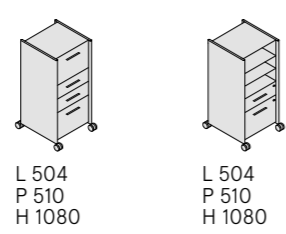

Condizioni generali di vendita.  
 Tutti i nostri prodotti possono essere personalizzati con una finitura selezionata tra quelle da noi proposte nella cartella finiture vernici e tessuti.  
 I prodotti del presente catalogo sono modelli brevettati. Tutti i diritti di legge sono riservati.  
 Nessuna parte di questa pubblicazione può essere riprodotta, registrata o trasmessa in nessuna forma o per alcun motivo (elettronico, meccanico, fotocopiato, registrato o altro) senza il preventivo permesso del proprietario del copyright. I trasgressori saranno perseguiti a termini di legge.

General conditions of sale.  
 Our products can be customized with a finish selected among the ones we proposed in the paints and fabrics finishes folder. The products found on this catalog are patented models. All legal rights are reserved.  
 No part of this publication may be reproduced, recorded or transmitted in any form or for any reason (electronic, mechanical, photocopied, recorded or otherwise) without the prior permission of the copyright owner. Offenders will be prosecuted under law.



Dieffebi SpA

via Palù 36  
31020 San Vendemiano,  
Treviso – Italia  
T +39 0438 4715  
F +39 0438 471600  
marketing@dieffebi.com  
exportsales@dieffebi.com  
venditeitalia@dieffebi.com  
www.dieffebi.com

Showroom Milano

Via Milazzo, 8  
20121 Milano

Showroom Londra

104 – 110 Goswell Road  
BDM – 2nd Floor  
London EC1V 7DH

Graphic design  
Designwork

Photography  
Tiziano Sartorio

Styling  
Alessandro Pasinelli Studio

Rendering  
Segnoprogetto

Copywriter  
Daniele Varelli

Text translation  
Transitus Group

Technical Drawings  
Matteo Lizzi

Printing  
Grafiche Filacorda  
with H-UV technology

Ed. Ottobre 2017  
Copyright©2017  
by Dieffebi SpA

Made and printed  
in Italy

Paper  
Fedrigoni Nettuno Blu Navy  
GardaPat 13 Bianca  
Sirio Color Perla

CATAGENER2017

[dieffebi.com](http://dieffebi.com)